



SmartGen
ideas for power

ALC404

LIGHTING TOWER CONTROLLER

USER MANUAL



SMARTGEN (ZHENGZHOU) TECHNOLOGY CO.,LTD.



Chinese trademark

SmartGen English trademark

SmartGen — make your generator *smart*

SmartGen Technology Co., Ltd.

No.28 Jinsuo Road

Zhengzhou

Henan Province

P. R. China

Tel: 0086-371-67988888/67981888

0086-371-67991553/67992951

0086-371-67981000(overseas)

Fax: 0086-371-67992952

Web: www.smartgen.com.cn

www.smartgen.cn

Email: sales@smartgen.cn

All rights reserved. No part of this publication may be reproduced in any material form (including photocopying or storing in any medium by electronic means or other) without the written permission of the copyright holder.

Applications for the copyright holder's written permission to reproduce any part of this publication should be addressed to SmartGen Technology at the address above.

Any reference to trademarked product names used within this publication is owned by their respective companies.

SmartGen Technology reserves the right to change the contents of this document without prior notice.



Table 1 - Version history

Date	Version	Contents
2017-12-06	1.0	Original release
2018-11-06	1.1	Modified rear panel drawing of controller; Updated partial details description.



This user manual only suits for ALC404 controller.

Table 2 - Notation Clarification

Symbol	Instruction
 NOTE	Highlights an essential element of a procedure to ensure correctness.
 CAUTION	Indicates a procedure or practice, which, if not strictly observed, could result in damage or destruction of equipment.
 WARNING	Indicates a procedure or practice, which could result in injury to personnel or loss of life if not followed correctly.

SmartGen



CONTENTS

1	OVERVIEW	6
2	PERFORMANCE AND CHARACTERISTICS	6
3	SPECIFICATION.....	9
4	OPERATION	10
4.1	PUSHBUTTONS.....	10
4.2	CONTROLLER PANEL	11
4.3	LCD DISPLAY.....	11
4.4	SCHEDULED START/STOP OPERATION.....	14
4.4.1	SCHEDULED START MODE SELECT OPERATION	14
4.4.2	SCHEDULED START OPERATION PROCESS	15
4.5	SUNRISE/SUNSET START OPERATION	16
4.5.1	SUNRISE/SUNSET START MODE SETTINGS.....	16
4.5.2	SUNRISE/SUNSET START/STOP OPERATION PROCESS.....	18
4.6	AUTO REMOTE START/STOP OPERATION.....	19
4.6.1	AUTO REMOTE START MODE SETTING	19
4.6.2	AUTO REMOTE START/STOP PROCESS OPERATION	20
4.7	MANUAL START/STOP OPERATION.....	21
4.8	FORCE START OPERATION	23
5	PROTECTIONS	24
5.1	WARNING ALARMS.....	24
5.2	SHUTDOWN ALARMS.....	27
5.3	TRIP AND STOP ALARMS.....	31
6	WIRING CONNECTION	32
7	SCOPES AND DEFINITIONS OF PROGRAMMABLE PARAMETERS	34
7.1	AUTO START PARAMETER SETTINGS.....	34
7.2	GENERIC PARAMETER SETTINGS.....	35
7.3	FLEXIBLE SENSOR 1 SETTINGS.....	50
7.4	FLEXIBLE SENSOR 2 SETTINGS.....	51
7.5	FLEXIBLE SENSOR 3 SETTINGS.....	53
7.6	SENSOR CURVE SELECTION.....	54
7.7	SENSOR SETTING	56
7.8	CONDITIONS OF CRANK DISCONNECT SELECTION	57
7.9	FUNCTION DEFINITION OF INPUT PORTS.....	58
7.10	DEFINITION OF PROGRAMMABLE INPUT PORT 1-5.....	60
7.11	ENABLE DEFINITION OF PROGRAMMABLE OUTPUT PORT.....	61
7.12	OVER CURRENT ACTION.....	65
7.13	LIGHT INPUT CONTROL MODE	66
7.14	BATTERY LOW VOLT AGE START MODE (INVALID WHILE MAINS SUPPLY POWER).....	66
7.15	TIMER MODE SELECT	67
7.16	SUNRISE/SUNSET SETTING	67
7.17	LOW FUEL LEVEL REDUCE LIGHT NUMBER (INVALID WHILE MAINS SUPPLY POWER)	67
7.18	REALIZE MAINS SUPPLY POWER VIA EXTERNAL DIGITAL INPUT PORT	67
7.19	DEEP SLEEP MODE	68



7.19.1	CONDITIONS OF ENTERING INTO DEEP SLEEP MODE.....	68
7.19.2	EXIT DEEP SLEEP MODE METHOD	68
8	PARAMETERS SETTING.....	69
8.1	SETTING MENU DESCRIPTION.....	69
8.2	PARAMETERS SETTING	69
8.3	CONTROLLER TIME CALIBRATION.....	69
8.4	LANGUAGE SELECTION	70
8.5	EVENT LOG	70
8.6	CONTROLLER INFORMATION.....	71
9	COMMISSIONING	71
10	CONNECTIONS OF CONTROLLER WITH J1939 ENGINE	72
10.1	CUMMINS ISB/ISBE.....	72
10.2	CUMMINS QSL9.....	72
10.3	CUMMINS QSM11 (IMPORT).....	73
10.4	CUMMINS QSX15-CM570	73
10.5	CUMMINS QSM11.....	73
10.6	CUMMINS QSZ13	74
10.7	DETROIT DIESEL DDEC III / IV	74
10.8	DEUTZ EMR2	74
10.9	JOHN DEERE.....	75
10.10	MTU MDEC.....	75
10.11	MTU ADEC(SMART MODULE).....	75
10.12	MTU ADEC (SAM MODULE).....	76
10.13	PERKINS	76
10.14	SCANIA.....	76
10.15	VOLVO EDC3.....	77
10.16	VOLVO EDC4.....	77
10.17	VOLVO-EMS2	77
10.18	YUCHAI	78
10.19	WEICHAI.....	78
11	TYPICAL WIRING DIAGRAMS	79
12	INSTALLATION.....	82
12.1	FIXING CLIPS.....	82
12.2	OVERALL AND CUTOUT DIMENSIONS.....	82
12.3	WIRING CONNECTION DESCRIPTION	82
13	TROUBLESHOOTING.....	83



1 OVERVIEW

ALC404 Lighting Tower Controller, suits for both AC and DC light tower set, is used for automation and monitor control systems of single light tower unit (diesel/petrol genset) to achieve not only scheduled start/stop, sunrise and sunset start/stop, manual start/stop as well as start/stop genset via remote input port but also turn on/off the flashlights of the light tower in proper order. It integrates with digitalization, intellectualization and network technologies and enjoys functions including precise data measurement, alarm protection as well as remote control, remote measuring and remote communication.

ALC404 Lighting Tower Controller adopts micro-processor technology and combines automation control function with beacon lights control function. It fits with performance including LCD display, selectable Chinese/English languages interface, modular design, compact structure, reliable operation and simple connections, which is very easy to use and convenient to maintain.

2 PERFORMANCE AND CHARACTERISTICS

- Based on microprocessor, fitted with 132x64 LCD screen with graphic icons and backlit, selectable Chinese/English languages interface and pushbuttons;
- Be compatible with both AC and DC light tower sets;
- Deep sleep function;
- Reducing the number of the lighting lamps along with the fuel level drops;
- With lamp fault check function;
- Starting battery under voltage condition can start gen-set to charge the start battery;
- Not only suitable for 3P4W, 3P3W, 1P2W, 2P3W(120V/240V) power system with 50Hz/60Hz frequency, but also suitable for DC power supply system;
- Collect and display parameters including generator/mains 3 phase voltage and current, frequency, and power as below,

Generator

Line voltage: U_{ab} , U_{bc} , U_{ca}

Phase voltage: U_a , U_b , U_c

Frequency: Hz

Load

Current: I_a , I_b , I_c Unit: A

Total active power: P Unit: kW

Total reactive power: Q Unit: kVar

Total apparent power: S Unit: kVA

Power factor: λ Unit: 1

Accumulated power generated: W Unit: kWh

Current accumulated power generated: W Unit: kWh

Mains(mains supply is active)

Line voltage: U_{ab} , U_{bc} , U_{ca}

Phase voltage: U_a , U_b , U_c

Frequency: Hz



- Generator with over voltage, under voltage, over frequency, under frequency, and over current functions; mains with over voltage, under voltage, over frequency and under frequency functions;
- Detect DC voltage, current, and power while controlling of DC light tower set;
- Precise collect generator parameters as below,

Temperature(programmable)	°C/°F		
Engine oil pressure (programmable)	kPa/bar/psi		
Fuel level (programmable)	%	Fuel left	L
Engine speed	r/min(RPM)		
Starter battery voltage	V		
D+ voltage of charger	V		
- Accumulated start times
- Accumulated running time
- Currently running time
- Precise real-time clock and real-time calendar functions allow scheduled start/stop (every day, every week, every month and custom week), sunrise and sunset start/stop light tower set; moreover, scheduled start time, running duration time, sunrise time and sunset time can be set by users as users' wish;
- Remote start/stop function;
- Manual start/stop control of light tower set and manual on/off control of lighting lamps;
- Standard USB communication port makes it easier to communicate with PC and faster to configure parameters; network monitoring can be achieved via USB port;
- CANBUS interface can connect with J1939 EFI engine, which can not only monitor the normal data of EFI engine (like water temp., oil pressure, speed, and fuel consumption), but also control gen-set start/stop and rise/drop speed via CANBUS port.
- Mains can supply power for controller lighting lamps or manual on/off control of lighting lamps.
- Gen-set running accumulation and output energy accumulation functions convenient for users to regular maintenance and fuel consumption statistics;
- Scheduled start time and various delays can be set on the spot and also comes with password protection in case of laypeople disoperation.
- ALC404 controller can control up to 4 lamps and 4 feedback indicators were be fitted on the panel. In addition, the turn on interval time between two lights can be set by users.



- 99 pieces of event logs can be circularly stored and inquired on the spot; also can be print or be inquired via PC.
- More kinds of curves of temperature, oil pressure, fuel level can be used directly and users can select “User Configured” sensor curves for unknown engine sensor ;
- Widely power supply range DC(8~35)V, suitable to different starting battery voltage environment;
- Modular design, pluggable terminal, built-in mounting, compact structure with easy installation;

SmartGen



3 SPECIFICATION

Table 3 – Technical Parameters















Items	Contents
Working Voltage	DC8. 0V to 35. 0V, uninterruptible power supply
Overall Consumption	≤3W (Standby mode: ≤2W; Deep Sleep mode: ≤0.2W)
Gen./Mains Voltage Input:	
3 Phase 4 Wire	15V AC - 360V AC (ph-N)
3 Phase 3 Wire	30V AC - 620V AC (ph-ph)
Single Phase 2 Wire	15V AC - 360V AC (ph-N)
2 Phase 3 Wire	15V AC - 360V AC (ph-N)
DC	0V DC - 75V DC
Alternator Frequency	50/60Hz
Speed Sensor Voltage	1. 0 V to 24 V (RMS)
Speed Sensor Frequency	Maximum 10,000 Hz
Starter Relay Output	5A DC B+ power supply output
Configurable Relay Output 1	5A DC B+ power supply output
Configurable Relay Output 2	1A DC B+ power supply output
Configurable Relay Output 3	1A DC B+ power supply output
Configurable Relay Output 4	1A DC30V volt free output
Configurable Relay Output 5	1A DC30V volt free output
Configurable Relay Output 6	1A DC30V volt free output
Configurable Relay Output 7	1A DC30V volt free output
Case Dimensions	135 mm x 110 mm x 44 mm
Panel Cutout	116mm x 90mm
AC CT Secondary Current	Rated: 5A
DC Current Input	Hall sensor's secondary side current: (4~20)mA
Working Conditions	Temperature: (-25~+70)°C Relative Humidity: (20~93)%RH
Storage Conditions	Temperature:(-25~+70)°C
Protection Level	IP65: rubber seal installed between the controller enclosure and panel fascia.
Insulation Intensity	Apply AC2.2kV voltage between high voltage terminal and low voltage terminal; The leakage current is not more than 3mA within 1min.
Weight	0.34kg



4 OPERATION

4.1 PUSHBUTTONS

Table 4 – Keys Description

Icon	Function	Description
	Stop/Reset	Stop running light tower set; Reset alarms in stop mode; Lamp test in stop mode (press at least 3 seconds); Quick stop in stopping process.
	Start	Start lighting tower set in manual mode; Quick start in starting process (press once to jump one status of light tower set).
	Manual Mode	Press this key to configure tower set as manual start mode.
	Auto Mode	Press this key and controller enters into auto start mode select interface; use   to select Auto Start mode and press  or  to confirm the selection.
	Light On/Off	Press this key to change-over screens between mains screen and light On/Off screen. In light On/Off screen (in manual mode), press  to turn off the light and press  to turn on the light.
	Menu / Confirm	Press this key to enter into menu screen. In parameter setting page, press this key to right shift cursor and confirm the setting information.
	Up / Config. "+"	Press this key to scroll screens in parameter display page, menu page and records query page; Up cursor and increase value in parameter setting page. Press this key to wake up controller while controller is in deep sleep mode; In light On/ Off screen (in manual mode), press this key to control the number of lighting lamps (press once to turn on one lamp).
	Down/Config. "-"	Press this key to scroll screens in parameter display page, menu page and records query page; Down cursor and decrease value in parameter setting page. Press this key to wake up controller while controller is in deep sleep mode; In light On/ Off screen (in manual mode), press this key to control the number of lighting lamps (press once to turn off one lamp).

4.2 CONTROLLER PANEL



Fig.1 - ALC404 Front Panel

▲NOTE: Partial indicators description,

Alarm Indicator: slowly flash when warning alarms occur; fast flash when shutdown alarms occur; not illuminate if no alarms occur.



Status Indicator: not illuminate while genset is standby; normally illuminate while genset is normal running.

4.3 LCD DISPLAY

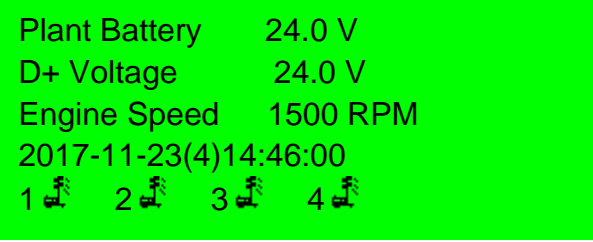

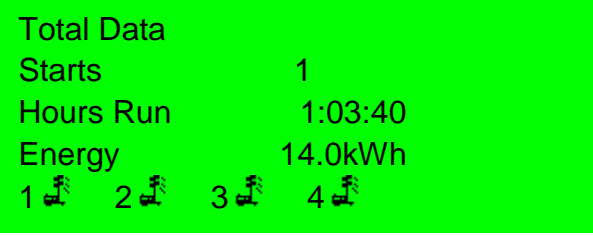

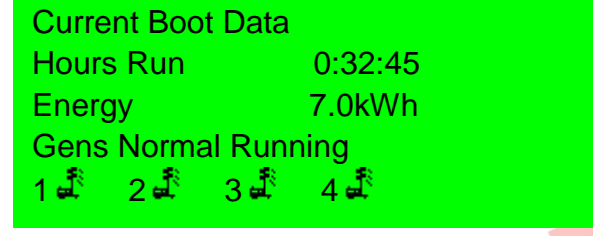

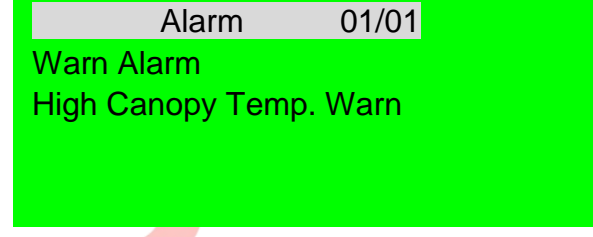

Table 5 - Main Screen Display

Mains Screen	Description
	<p>First screen displays all lights status, average voltage, generator frequency, generator speed, water temperature, oil pressure, fuel level, light tower set running status, and alarm information.</p> <p> Light On; Light Off; Battery; Speed; Generator; Mains; Coolant Temp.; Oil Pressure; Fuel Level; </p> <p>Note: coolant temp., oil pressure, and fuel level its related data collected by the sensors (if connect with EFI engine, data of coolant temp. and oil pressure are provided by ECU)</p>



Mains Screen	Description
<p>Manual Mode Manual Start Current Time 14:45:15 Gens Normal Running 1 2 3 4</p>	<p>Second screen display: Lighting tower set running status, current time, alarm information and etc.</p>
<p>Generator UL-L 399 399 399 V UL-N 230 230 230 V F = 50.0 Hz 1500RPM 1 2 3 4</p>	<p>Press  button</p> <p>The screen displays generator line voltage(L1-L2, L2-L3, L3-L1), phase voltage(L1、L2、L3), frequency and engine speed.</p> <p>DC light tower set without this page.</p>
<p>Load Current 19.9 19.9 19.9 A Power 13.7kW 0.0kVar PF = 1.00 PS 13.7kVA 1 2 3 4</p>	<p>Press  button</p> <p>The screen displays load current, total active power, total apparent power, total reactive power and power factor. If current and power values below 100, parameters will retain one decimal; if current and power values equal or above 100, no decimal will be displayed, and users can check precise data via PC software.</p> <p>The screen display DC voltage, current and power when DC current is fitted.</p>
<p>Engine Temp. 80°C Oil Pressure 400 kPa Fuel Level 80 % Gens Normal Running 1 2 3 4</p>	<p>Press  button</p> <p>The screen displays lighting tower set input values of flexible sensors.</p> <p>If one sensor is configured as “Not Used”, no information about this sensor will be displayed; if the sensor open circuit, “++++” will be displayed; if the sensor curve configured as “DIN High Activate” or “DIN Low Activated”, “HHHH” or “LLLL” will be displayed.</p>



Mains Screen	Description
	<p>Press  button</p> <p>The screen displays battery voltage, charger voltage, engine speed of lighting tower set and current time of controller (the number in the parentheses is week information).</p>
	<p>Press  button</p> <p>The screen displays accumulated start times, accumulated output active energy, accumulated run time (HH: MM: SS).</p>
	<p>Press  button</p> <p>The screen displays currently start time (HH: MM: SS) and output active energy of this time.</p>
	<p>Press  button</p> <p>The screen displays alarms information that detected by the controller.</p>



4.4 SCHEDULED START/STOP OPERATION

4.4.1 SCHEDULED START MODE SELECT OPERATION

Scheduled start operation has four modes to choose (00 daily, 01 weekly, 02 monthly and 03 custom week). The following content take the Scheduled Start (00 daily) as the example, and the other modes' operation method is likewise. Detailed operation process is as below,

Table 6 – Scheduled Start Setting

No.	Process	Description	Panel Display
1	Enter into Auto Start Mode Selection navigation screen	Press key to enter into Auto Start mode, indicator besides it illuminates, simulteniouly, Auto Start Mode Selection screen will be displayed. Then choose 02 Scheduled Start via pressing or .	<p>Auto Start Mode Selection</p> <p>01 Remote Start Mode</p> <p>02 Auto Timer Mode</p> <p>03 Sunrise/set Mode</p>
2	Enter into Auto Timer Mode detailed setting navigation screen	Press key to enter into Auto Timer Mode setting screen, and select 03 Timer Configure option via pressing or . Then press or to enter into Timer Runing Action setting page and choose 01 Timer Mode Select through pressing and .	<p>Timer Running Action Return</p> <p>01 Mode Start</p> <p>02 Mode Close</p> <p>03 Timer Configure</p> <p>Timer Running Action Return</p> <p>01Timer Mode Select</p> <p>02Auto Run Timer Set</p>
3	Timer Mode Select	Press key to enter into 01 Timer Mode Select setting screen, and press again to select 00 Daily option via pressing or . Then press to confirm and save the setting. At this time, through pressing or to return to auto timer mode detailed setting navigation screen.	<p>01Timer Mode Select</p> <p>00Daily</p> <p>00Daily</p>
4	Auto Run Timer Set	<p>In auto timer mode detailed setting screen, press or to select 02Auto Run Timer Set.</p> <p>Press to enter into 02Auto Run Timer Set screen, and then press again to configure Start Time and Duration Time through , and keys.</p> <p>If setting completely, press or to return to the auto timer mode detailed setting navigation screen and select Return by pressing or keys.</p> <p>Press to return to Auto Timer Mode</p>	<p>Timer Running Action Return</p> <p>01Timer Mode Select</p> <p>02Auto Run Timer Set</p> <p>Timer Running Action</p> <p>02Auto Run Timer Set</p> <p>Start Time Duration</p> <p>18:30 12:00</p>



No.	Process	Description	Panel Display
		detailed setting navigation screen, and select Return through or , and then press to return to Timer Running Action confirmation screen.	
5	Timer Running Action Start/Close	<p>Select 01 Mode Start via or key and press to confirm the action. Controller will jump to the 2nd page of main screen, at this point, Aoto Mode (Daily) start.</p> <p>Select 02 Mode Close via or keys and press to confirm the action. Controller will jump to the 2nd page of main screen, at this point, Aoto Mode (Daily) closed.</p>	

4.4.2 SCHEDULED START OPERATION PROCESS

Table 7 – Scheduled Start/Stop Operation

No.	Operation Process	Panel Display
1	Configure the controller as scheduled start mode and choose “Timer Mode (00 Daily)”, and start time set as 18:30, continuous running time (hours run) set as 12:00(12hours).	
2	<p>When there are 10s left from start time, audible alarm relay is active (if configured, when start time is up, audible alarm relay will stop output). When start time is up and start remaining time is more than 0s, light tower set begin cranking.</p> <p>Continuous running countdown will be displayed on the first line.</p>	



No.	Operation Process	Panel Display
3	If engine speed, generator voltage and frequency has reached on-load requirements (speed \geq on-load speed, voltage \geq on-load voltage and frequency \geq on-load frequency), all the lights will illuminate in proper order and the illumination interval delay is 2s (can be set as 1s ~300s).	<p>Time Left 11:58:57 Start Time 18:30:00 Current Time 18:31:02 3# Light On 2s 1 2 3 4 </p> <p>Time Left 11:58:48 Start Time 18:30:00 Current Time 18:31:11 Gens Normal Running 1 2 3 4 </p>
4	When “stop delay” time is 00:00:00 manually select 02 Mode Close in Auto Timer Mode screen (01 Mode Start must be reselect if another time scheduled start is needed), and then press to confirm the act. then 1#~#4 lights will off in proper order and the extinguishing interval delay can be set as 1s~300s. The light tower set begin stopping when all the lights off.	<p>Time Left 00:00:00 Start Time 18:30:00 Current Time 06:30:00 4# Light Off 2s 1 2 3 4 </p> <p>Auto Timer Mode (Daily) Start Time 18:30:00 Current Time 06:30:39 Cooling Delay 29s 1 2 3 4 </p>
<p>Remark: The auto timer mode will be canceled automatically when select other auto start mode! if select Auto Timer Mode(Daily), lighting tower set will be auto started everyday at the pre-set time.</p>		

4.5 SUNRISE/SUNSET START OPERATION

4.5.1 SUNRISE/SUNSET START MODE SETTINGS

Table 8 – Sunrise/Sunset Start Operation

No.	Process	Description	Panel Display
1	Download city info via PC software	Users should connect PC and ALC400 controller using USB communication line and test ALC404 software, procedures are as follows: Open test software—edit config.—set sunrise/sunset—select city/user-defined city information (longitude, latitude and time zone) — download PC software information to the controller. After download finished, choose any	/



No.	Process	Description	Panel Display
		other city to re-read configuration, and then return back to the sunset/sunrise start screen to confirm that whether the city to be chosen is the one downloaded a moment ago or not.	
2	Enter into Auto Timer Mode detailed setting navigation screen	Press , its indicator lights on, and lighting tower set enters into Timer Mode Select screen. Meanwhile, the panel display Timer Mode Select screen; Press and to select 03 Sunrise/Sunset Mode .	Timer Mode Select 01 Remote Start Mode 02 Auto Timer Mode 03 Sunrise/set Mode
3	Enter into Sunrise/Sunset Action detailed setting navigation screen	Press key to enter into Sunrise/Sunset Mode setting navigation screen, and select 03 Sunrise/Sunset Mode via pressing and keys.	Sunrise/set Action Return 01 Mode Start 02 Mode Close 03 Sunset Time Delay 03 Sunset Time Delay CurrentVal +00000min +00000
4	Sunset start time delay setting	Press to enter into Sunset Time Delay setting screen, and configure the delay value through or key after pressing (delay value can be configured as "+" ahead of preset start time and "-" after of preset start time). And then press key to save the setting into the controller. Meanwhile, press or to return to Sunrise/set Action setting screen.	03 Sunset Time Delay CurrentVal +00000min +00000
5	Sunset stop time delay setting	In Sunrise/set Action setting navigation screen, press or to select 04 Sunrise Time Delay and press to enter the setting page. Press again and configure the delay value through or key (delay value can be configured as "+" ahead of preset stop time and "-" after preset of stop time). And then press key to save the setting into the controller. Meanwhile, press or to return to Sunrise/set Action setting screen.	Sunrise/set Action 01 Mode Start 02 Mode Close 03 Sunset Time Delay 04 Sunrise Time Delay



No.	Process	Description	Panel Display
			<p>04 Sunrise Time Delay</p> <p>CurrentVal +00000min +00000</p>
6	Timer Running Action Start/Close	<p>Select 01 Mode Start via ▲ or ▼ key and press ⚙️ to confirm the action. Controller will jump to the 2nd page of main screen, at this point, Sunrise/set Mode set completely.</p> <p>Select 02 Mode Close via ▲ or ▼ keys and press ⚙️ to confirm the action. Controller will jump to the 2nd page of main screen, at this point, Sunrise/set Mode closed.</p>	<p>Sunrise/set Action Return</p> <p>01 Mode Start</p> <p>02 Mode Close</p> <p>03 Sunset Time Delay</p> <p>Auto Sunrise/set Mode</p> <p>Start Time 16:55:00</p> <p>Current Time 16:54:50</p> <p>Standby</p> <p>1 2 3 4</p>

4.5.2 SUNRISE/SUNSET START/STOP OPERATION PROCESS

Table 9 – Sunrise/Sunset Start/Stop Operation Process

No.	Operation Process	Panel Display
1	Configure the controller as Auto Sunrise/set Mode, city information as Beijing via PC software, sunset start time delay as +0min and sunrise stop time delay as +0min. The actual start ime is 16:55:00 and stop time is 07:06:00.	<p>Auto Sunrise/set Mode</p> <p>Start Time 16:55:00</p> <p>Current Time 16:54:50</p> <p>Standby</p> <p>1 2 3 4</p>
2	When there are 10s left from start time (start time can be configured via PC software), audible alarm relay is active (if configured, when start time is up, audible alarm relay will stop output). When start time is up, light tower set begin cranking. Stop time will be displayed on the first line.	<p>Auto Sunrise/set Mode</p> <p>Start Time 16:55:00</p> <p>Current Time 16:54:50</p> <p>Standby</p> <p>1 2 3 4</p> <p>Stop Time 07:06:00</p> <p>Start Time 16:55:00</p> <p>Current Time 16:55:00</p> <p>Fuel Output Delay 1s</p> <p>1 2 3 4</p>



No.	Operation Process	Panel Display
3	If engine speed, generator voltage and frequency has reached on-load requirements (speed ≥ on-load speed, voltage ≥ on-load voltage and frequency ≥ on-load frequency), all the lights will illuminate in proper order and the illumination interval delay is 2s (can be set as 1s~300s).	<p>Stop Time 07:06:00 Start Time 16:55:00 Current Time 16:55:54 2# Light On 2s 1 2 3 4 </p> <p>Stop Time 07:06:00 Start Time 16:55:00 Current Time 15:56:00 Gens Normal Running 1 2 3 4 </p>
4	When “Current Time” is 07:06:00 (controller’s current time can be set via PC software) manually select 02 Mode Close(if select, light tower set will not start according to the sunset time unless to reselect 01 Mode Start), then 1#~4# lights will off in proper order and the extinguishing interval delay can be set as 1s~300s. The light tower set begin stopping when all the lights off.	<p>Stop Time 07:06:00 Start Time 16:55:00 Current Time 07:06:00 4# Light Off 2s 1 2 3 4 </p> <p>Auto Sunrise/set Mode Start Time 16:55:00 Current Time 07:06:09 Stop Cooling Delay 59s 1 2 3 4 </p>

Remark: The Sunrise/Sunset mode will be canceled automatically when select other auto start mode !





4.6 AUTO REMOTE START/STOP OPERATION

4.6.1 AUTO REMOTE START MODE SETTING

Table 10 – Auto Remote Start Mode Setting





















No.	Process	Description	Panel Display
1	Config input port	Configure input port 1 as Remote Start Input.	/
2	Enter into Auto Timer Mode detailed setting navigation screen	Press @ , its indicator lights on, and lighting tower set enters into Auto Start Mode . Meanwhile, the panel display Timer Mode Select screen; Press ▲ and ▼ to select 01 Remote Start Mode.	<p>Timer Mode Select 01 Remote Start Mode 02 Auto Timer Mode 03 Sunrise/set Mode</p>



No.	Process	Description	Panel Display
3	Confirm remote start mode	Press  to confirm remote start mode, and then controller will jump to the 2 nd page. Meanwhile, remote start mode set completely.	Remote Start Mode Wait Remote Start Current Time 17:30:00 Standby 1  2  3  4 

4.6.2 AUTO REMOTE START/STOP PROCESS OPERATION

Table 11 – Remote Start/Stop Operation

No.	Operation Process	Panel Display
1	Configure controller as Remote Start Mode.	Remote Start Mode Wait Remote Start Current Time 17:30:00 Standby 1  2  3  4 
2	When remote start input port is active, remote start delay begins and audible alarm relay is active (if configured). When remote start delay is over and remote start signal is active, light tower set begins cranking.	Remote Start Mode Start Delay 5s Current Time 17:30:01 Standby 1  2  3  4  Remote Start Mode Remote Start Current Time 17:30:06 Fuel Output 1s 1  2  3  4 
3	If engine speed, generator voltage and frequency has reached on-load requirements (speed \geq on-load speed, voltage \geq on-load voltage and frequency \geq on-load frequency), all the lights will illuminate in proper order and the illumination interval delay is 2s (can be set as 1s~300s).	Remote Start Mode Remote Start Current Time 17:30:58 1# Light On 2s 1  2  3  4 
4	When remote start input port is inactive, remote stop delay begins; when stop delay is over, 1#~4# lights will off in proper order and the extinguishing interval delay can be set as 1s~300s. The light tower set begin stopping when all the lights off.	Remote Start Mode Stop Delay 5s Current Time 07:00:00 Gens Normal Running 1  2  3  4 



No.	Operation Process	Panel Display
		<div style="background-color: #00FF00; padding: 5px;"> Remote Start Mode Wait Remote Start Current Time 07:00:09 3# Light Off 2s 1 2 3 4 </div> <div style="background-color: #00FF00; padding: 5px; margin-top: 10px;"> Remote Start Mode Wait Remote Start Current Time 07:00:15 Cooling Time 59s 1 2 3 4 </div>

Remark: The Remote start/stop mode will be canceled automatically when select other auto start mode !

4.7 MANUAL START/STOP OPERATION

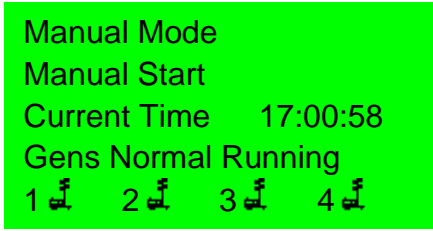

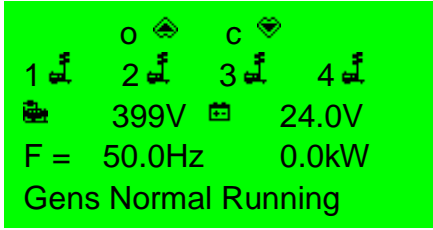
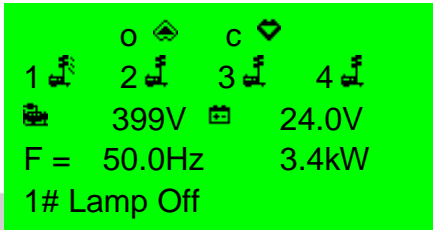

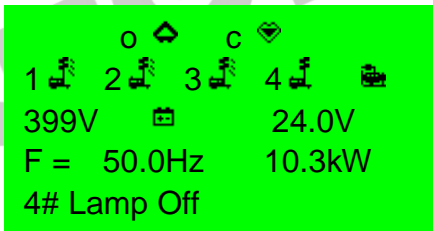
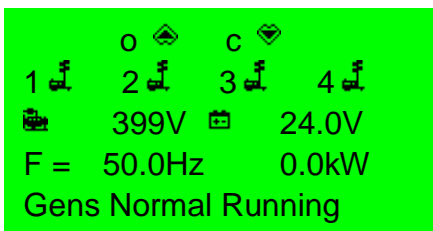

Table 12 - Light On/Off Screen

Main Screen	Description
<div style="background-color: #00FF00; padding: 5px;"> O C 1 2 3 4 399V 24.0V F = 50.0Hz 0.0kW Gens Normal Running </div>	Press key to enter into Light On/Off screen, and press again to exit. This screen shows users how to manually turn on/off lights. “O” stands for “Open”, refers to and means is active; “C” stands for “Close”, refers to and means is active;

Table 13 - Manually Start/Stop Unit Operation



No.	Operation Process	Panel Display
1	Press , its indicator lights on, and controller enters Manual Mode. Press , light tower set begins cranking	<div style="background-color: #00FF00; padding: 5px;"> Manual Mode Wait Manual Start Current Time 17:00:00 Standby 1 2 3 4 </div> <div style="background-color: #00FF00; padding: 5px; margin-top: 10px;"> Manual Mode Manual Start Current Time 17:00:02 Cranking 5s 1 2 3 4 </div>

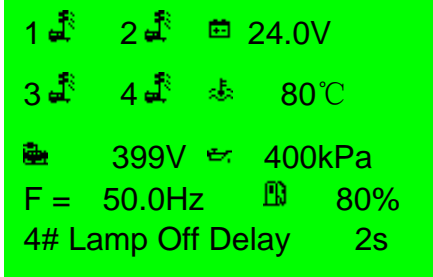
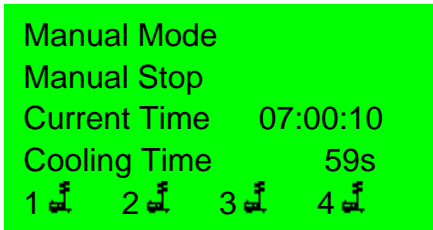

No.	Operation Process	Panel Display
2	<p>If light tower set high-speed warming up is over, meanwhile, engine speed, generator voltage and frequency has reached on-load requirements (speed \geq on-load speed, voltage \geq on-load voltage and frequency \geq on-load frequency), and then light tower set enters into normal running process.</p>	
3	<p>Press  enters into Light On/Off screen, press  1#~4# lights will illuminate in proper order (press once, one light on).</p>	 
4	<p>If manually turn off the light, press  in Light On/Off screen, 4#~1# lights will off in proper order (press once, one light off).</p>	 
5	<p>If users need to stop the light tower set, press , 1#~4# lights will off in proper order when all lights are in illuminated status, and the extinguishing interval delay can be set as 1s~300s (can be configured). The light tower set begin stopping when the lights are off. Press  again during this procedure will lead to all lights off at the same time and controller enters into ETS status.</p>	 



4.8 FORCE START OPERATION

Simultaneously pressing  and  in manual mode can force start light tower set, at the moment, starter disconnect controlled by the operator instead of judging from crank disconnect conditions. When light tower set successfully start, operator will release the keys and controller enters into safety running delay.

SmartGen



5 PROTECTIONS

5.1 WARNING ALARMS

Warnings are not lead to light tower set shutdown and alarm information will be displayed on the LCD.

Table 14 - Warning Alarms

No.	Type	Description
1	High Temperature	When controller detects the high temperature input is active, it will send warning signal and the corresponding alarm information will be displayed on the LCD.
2	Low Oil Pressure	When controller detects the low oil pressure warning input is active, it will send warning signal and the corresponding alarm information will be displayed on the LCD.
3	Over Speed	When controller detects the engine speed of light tower set is higher than the set value, it will send warning signal and the corresponding alarm information will be displayed on the LCD.
4	Under Speed	When controller detects the engine speed of light tower set is lower than the set value, it will send warning signal and the corresponding alarm information will be displayed on the LCD.
5	Loss of Speed Signal	When controller detects the engine speed of light tower set is 0, and action select "Warning", it will send warning signal and the corresponding alarm information will be displayed on the LCD.
6	Generator Over Frequency	If it is enabled, when controller detects the frequency of light tower set is higher than the set value, it will send warning signal and the corresponding alarm information will be displayed on the LCD.
7	Generator Under Frequency	If it is enabled, when controller detects the frequency of light tower set is lower than the set value, it will send warning signal and the corresponding alarm information will be displayed on the LCD.
8	Generator Over Voltage	If it is enabled, when controller detects the voltage of light tower set is higher than the set value, it will send warning signal and the corresponding alarm information will be displayed on the LCD.
9	Generator Under Voltage	If it is enabled, when controller detects the voltage of light tower set is lower than the set value, it will send warning signal and the corresponding alarm information will be displayed on the LCD.
10	Generator Over Current	If it is enabled, when controller detects the current of light tower set is higher than the set value, it will send warning signal and the corresponding alarm information will be displayed on the LCD.
11	Fail to Stop	If light power set fail to stop after the "ETS solenoid hold/ wait for stop delay" is expired, it will send warning signal and the corresponding alarm information will be displayed on the LCD.



No.	Type	Description
12	Low Fuel Level	When controller detects the low fuel level warning input is active, it will send warning signal and the corresponding alarm information will be displayed on the LCD.
13	Charge Alt Fail	If it is enabled, when controller detects the charger voltage of light tower set is lower than the set value, it will send warning signal and the corresponding alarm information will be displayed on the LCD.
14	Battery Under Voltage	If it is enabled, when controller detects the battery voltage is lower than the set value, it will send warning signal and the corresponding alarm information will be displayed on the LCD.
15	Battery Over Voltage	When controller detects the battery voltage is higher than the set value, it will send warning signal and the corresponding alarm information will be displayed on the LCD.
16	Low Coolant Level	When controller detects coolant level warning input is active, it will send warning signal and the corresponding alarm information will be displayed on the LCD.
17	Input 1 Warning	When input port 1-5 is selected as user defined and action type choose warning alarm, if input port is active, controller will send warning signal and the corresponding alarm information will be displayed on the LCD. If input name is configured by users as xxx, then "xxx Warning" will be displayed on the LCD.
18	Input 2 Warning	
19	Input 3 Warning	
20	Input 4 Warning	
21	Input 5 Warning	
22	External Charge Fail	When controller detects external charge fail input is active, it will send warning signal and the corresponding alarm information will be displayed on the LCD.
23	Light Fault Warning	If it is enabled, when controller detects the beacon lamp failure, and action select warning, it will send warning signal and the corresponding alarm information will be displayed on the LCD.
24	Sensor 1 Low	If it is enabled, when controller detects the sensor value is lower than the minimum set value, it will send warning signal and the corresponding alarm information will be displayed on the LCD. If the sensor name is configured by users as xxx, then "xxx Low" warning will be displayed on the LCD.
25	Sensor 2 Low	
26	Sensor 3 Low	
27	Sensor 1 High	If it is enabled, when controller detects the sensor value is higher than the maximum set value, it will send warning signal and the corresponding alarm information will be displayed on the LCD. If the sensor name is configured by users as xxx, then "xxx High" warning will be displayed on the LCD.
28	Sensor 2 High	
29	Sensor 3 High	
30	Sensor 1 Open Circuit	When controller detects the programmable sensor is open circuit, meanwhile, action select as warning, it will send warning signal and the corresponding alarm information will be displayed on the LCD. If the sensor name is configured by users as xxx, then "xxx Open Circuit" warning will be displayed on the LCD.
31	Sensor 2 Open Circuit	
32	Sensor 3 Open Circuit	



No.	Type	Description
33	ECU Warning	When controller receives engine warning alarm signals via J1939, it will send warning signal and corresponding alarm information will be displayed on the LCD.
34	ECU Coolant Temp. High	If it is enabled, when controller detects the coolant temperature transferred by EFI engine is higher than the maximum limit of preset value, it will send warning signal and the corresponding alarm information will be displayed on the LCD.
35	ECU Oil Pressure Low	If it is enabled, when controller detects the oil pressure transferred by EFI engine is lower than the minimum limit of preset value, it will send warning signal and the corresponding alarm information will be displayed on the LCD.
36	Low Fuel Level Light-off	If it is enabled, when controller detects the fuel level of light tower set is lower than the preset light-off value, it will send warning signal and the corresponding alarm information will be displayed on the LCD.
37	Mains Over Frequency	If it is enabled, when controller detects the frequency of mains is higher than the maximum limit of preset value, it will send warning signal and the corresponding alarm information will be displayed on the LCD.
38	Mains Under Frequency	If it is enabled, when controller detects the frequency of mains is lower than the minimum limit of preset value, it will send warning signal and the corresponding alarm information will be displayed on the LCD.
39	Mains Over Voltage	If it is enabled, when controller detects the voltage of mains is higher than the maximum limit of preset value, it will send warning signal and the corresponding alarm information will be displayed on the LCD.
40	Mains Under Voltage	If it is enabled, when controller detects the voltage of mains is lower than the minimum limit of preset value, it will send warning signal and the corresponding alarm information will be displayed on the LCD.



5.2 SHUTDOWN ALARMS

When controller detects shutdown alarm, it will send signal to turn off #1~#4 lights and shuts down generator and corresponding alarm information will be displayed on LCD.

Table 15 - Shutdown Alarms

No.	Type	Description
1	Emergency Stop	When controller detects emergency stop signal, it will send a shutdown signal and the corresponding alarm information will be displayed on the LCD.
2	High Temp. Shutdown	When controller detects the High Temp. Shutdown input is active, it will send a shutdown signal and the corresponding alarm information will be displayed on the LCD.
3	Low Oil Pressure Shutdown	When controller detects the Low Oil Pressure Shutdown input is active, it will send a shutdown signal and the corresponding alarm information will be displayed on the LCD.
4	Light Fault Shutdown	If it is enabled, when controller detects the beacon lamp failure, and action select shutdown, it will send shutdown signal and the corresponding alarm information will be displayed on the LCD.
5	Over Speed	When controller detects the generator speed is higher than the maximum limit of preset value, it will send a shutdown signal and the corresponding alarm information will be displayed on the LCD.
6	Under Speed	If it is enabled, when controller detects the generator speed is lower than the minimum limit of preset value, it will send a shutdown signal and the corresponding alarm information will be displayed on the LCD.
7	Loss of Speed Signal	When controller detects the generator speed is 0, meanwhile, action select as shutdown, it will send a shutdown signal and the corresponding alarm information will be displayed on the LCD.
8	Over Frequency	If it is enabled, when controller detects the generator frequency is higher than the maximum limit of preset value, it will send a shutdown signal and the corresponding alarm information will be displayed on the LCD.
9	Under Frequency	If it is enabled, when controller detects the generator frequency is lower than the minimum limit of preset value, it will send a shutdown signal and the corresponding alarm information will be displayed on the LCD.
10	Over Voltage	If it is enabled, when controller detects the generator voltage is higher than the maximum limit of preset value, it will send a shutdown signal and the corresponding alarm information will be displayed on the LCD.
11	Under Voltage	If it is enabled, when controller detects the generator voltage is lower than the minimum limit of preset value, it will send a shutdown signal and the corresponding alarm information will be displayed on the LCD.



No.	Type	Description
12	Over Current	If it is enabled, when controller detects the current is higher than the maximum limit of preset value, meanwhile, action select as shutdown, it will send a shutdown signal and the corresponding alarm information will be displayed on the LCD.
13	Fail To Start	If gen-set start failure within setting of start times, it will send a shutdown signal and the corresponding alarm information will be displayed on the LCD.
14	Pressure Sensor Open Circuit	When controller detects the Pressure Sensor Open Circuit input is active, it will send shutdown signal and the corresponding alarm information will be displayed on the LCD.
15	Input 1 Shutdown	When input port 1 is selected as user defined and action type choose shutdown alarm, if input port is active, controller will send warning signal and the corresponding alarm information will be displayed on the LCD. If input name is configured by users as xxx, then "xxx Shutdown" will be displayed on the LCD.
16	Input 2 Shutdown	When input port 2 is selected as user defined and action type choose shutdown alarm, if input port is active, controller will send warning signal and the corresponding alarm information will be displayed on the LCD. If input name is configured by users as xxx, then "xxx Shutdown" will be displayed on the LCD.
17	Input 3 Shutdown	When input port 3 is selected as user defined and action type choose shutdown alarm, if input port is active, controller will send warning signal and the corresponding alarm information will be displayed on the LCD. If input name is configured by users as xxx, then "xxx Shutdown" will be displayed on the LCD.
18	Input 4 Shutdown	When input port 4 is selected as user defined and action type choose shutdown alarm, if input port is active, controller will send warning signal and the corresponding alarm information will be displayed on the LCD. If input name is configured by users as xxx, then "xxx Shutdown" will be displayed on the LCD.
19	Input 5 Shutdown	When input port 5 is selected as user defined and action type choose shutdown alarm, if input port is active, controller will send warning signal and the corresponding alarm information will be displayed on the LCD. If input name is configured by users as xxx, then "xxx Shutdown" will be displayed on the LCD.
20	Low Fuel Level	When controller detects the Low Fuel Level input is active, it will send shutdown signal and the corresponding alarm information will be displayed on the LCD.
21	Sensor 1 Low	If it is enabled, when controller detects the sensor 1 value is lower than the minimum limit of preset value, it will send shutdown signal and the corresponding alarm information will be displayed on the LCD. If the sensor name is configured by users as xxx, then "xxx Low" shutdown information will be displayed on the LCD.



No.	Type	Description
22	Sensor 2 Low	If it is enabled, when controller detects the sensor 2 value is lower than the minimum limit of preset value, it will send shutdown signal and the corresponding alarm information will be displayed on the LCD. If the sensor name is configured by users as xxx, then “xxx Low” shutdown information will be displayed on the LCD.
23	Sensor 3 Low	If it is enabled, when controller detects the sensor 3 value is lower than the minimum limit of preset value, it will send shutdown signal and the corresponding alarm information will be displayed on the LCD. If the sensor name is configured by users as xxx, then “xxx Low” shutdown information will be displayed on the LCD.
24	Sensor 1 High	If it is enabled, when controller detects the sensor 1 value is higher than the maximum limit of preset value, it will send shutdown signal and the corresponding alarm information will be displayed on the LCD. If the sensor name is configured by users as xxx, then “xxx High” shutdown information will be displayed on the LCD.
25	Sensor 2 High	If it is enabled, when controller detects the sensor 2 value is higher than the maximum limit of preset value, it will send shutdown signal and the corresponding alarm information will be displayed on the LCD. If the sensor name is configured by users as xxx, then “xxx High” shutdown information will be displayed on the LCD.
26	Sensor 3 High	If it is enabled, when controller detects the sensor 3 value is higher than the maximum limit of preset value, it will send shutdown signal and the corresponding alarm information will be displayed on the LCD. If the sensor name is configured by users as xxx, then “xxx High” shutdown information will be displayed on the LCD.
27	Temp. Sensor Open Circuit	When controller detects the Temp. Sensor Open Circuit Shutdown input is active, it will send shutdown signal and the corresponding alarm information will be displayed on the LCD.
28	Sensor 1 Open Circuit	When controller detects the programmable sensor 1 is open circuit, meanwhile, action select as shutdown, it will send shutdown signal and the corresponding alarm information will be displayed on the LCD. If the sensor name is configured by users as xxx, then “xxx Open Circuit” shutdown will be displayed on the LCD.
29	Sensor 2 Open Circuit	When controller detects the programmable sensor 2 is open circuit, meanwhile, action select as shutdown, it will send shutdown signal and the corresponding alarm information will be displayed on the LCD. If the sensor name is configured by users as xxx, then “xxx Open Circuit” shutdown will be displayed on the LCD.
30	Sensor 3 Open Circuit	When controller detects the programmable sensor 3 is open circuit, meanwhile, action select as shutdown, it will send shutdown signal and the corresponding alarm information will be displayed on the LCD. If the sensor name is configured by users as xxx, then “xxx Open Circuit” shutdown will be displayed on the LCD.



No.	Type	Description
31	Coolant Level Low	When controller detects the Coolant Level Low Shutdown input is active, it will send shutdown signal and the corresponding alarm information will be displayed on the LCD.
32	ECU Shutdown	When controller receives engine shutdown alarm signals via J1939, it will send shutdown signal and corresponding alarm information will be displayed on the LCD.
33	ECU Communicate Fail	When engine is firing, controller receives no data via J1939, it will send shutdown signal and the corresponding alarm information will be displayed on the LCD.
34	ECU Coolant Temp. High	If it is enabled, when controller detects the coolant temperature transferred by EFI engine is higher than the maximum limit of preset value, it will send shutdown signal and the corresponding alarm information will be displayed on the LCD.
35	ECU Oil Pressure Low	If it is enabled, when controller detects the oil pressure transferred by EFI engine is lower than the minimum limit of preset value, it will send shutdown signal and the corresponding alarm information will be displayed on the LCD.
36	Low Voltage Start Charging Timeout	After low starter battery voltage start is active, if charging time exceeds the pre-set max. charging time, it will send shutdown signal and the corresponding alarm information will be displayed on the LCD.

NOTE: The shutdown alarm types of input ports are active only when they are configured by users.

NOTE: for ECU warning and shutdown alarm illustration, if detailed alarm content displayed, users can check engine according to the details; otherwise, users can check engine manual based on the SPN alarm codes to achieve the information.



5.3 TRIP AND STOP ALARMS

When the controller detects trip and stop signal, it will send signal to turn off #1~#4 lights and then generator cooling down and stop.

Table 16 – Trip and Stop Alarms

No.	Type	Detection range	Description
1	Over Current	Always active	When controller detects the current is higher than the maximum limit of preset value, it will send a “trip and stop” signal and the corresponding alarm information will be displayed on the LCD.
2	Digital Input 1 Trip and Stop	User-defined	When the controller detects digital input port 1 trip alarms, it will send a “trip and stop” alarm signal and the corresponding alarm information will be displayed on the LCD. If the input port name is configured by users as xxx, then “xxx trip and stop” will be displayed on the LCD.
3	Digital Input 2 Trip and Stop	User-defined	When the controller detects digital input port 2 trip alarms, it will send a “trip and stop” alarm signal and the corresponding alarm information will be displayed on the LCD. If the input port name is configured by users as xxx, then “xxx trip and stop” will be displayed on the LCD.
4	Digital Input 3 Trip and Stop	User-defined	When the controller detects digital input port 3 trip alarms, it will send a “trip and stop” alarm signal and the corresponding alarm information will be displayed on the LCD. If the input port name is configured by users as xxx, then “xxx trip and stop” will be displayed on the LCD.
5	Digital Input 4 Trip and Stop	User-defined	When the controller detects digital input port 4 trip alarms, it will send a “trip and stop” alarm signal and the corresponding alarm information will be displayed on the LCD. If the input port name is configured by users as xxx, then “xxx trip and stop” will be displayed on the LCD.
6	Digital Input 5 Trip and Stop	User-defined	When the controller detects digital input port 5 trip alarms, it will send a “trip and stop” alarm signal and the corresponding alarm information will be displayed on the LCD. If the input port name is configured by users as xxx, then “xxx trip and stop” will be displayed on the LCD.

 **NOTE:** The trip and stop alarm types of digital input ports are active only when they are configured by users.

6 WIRING CONNECTION

ALC404 controller's rear is as following:

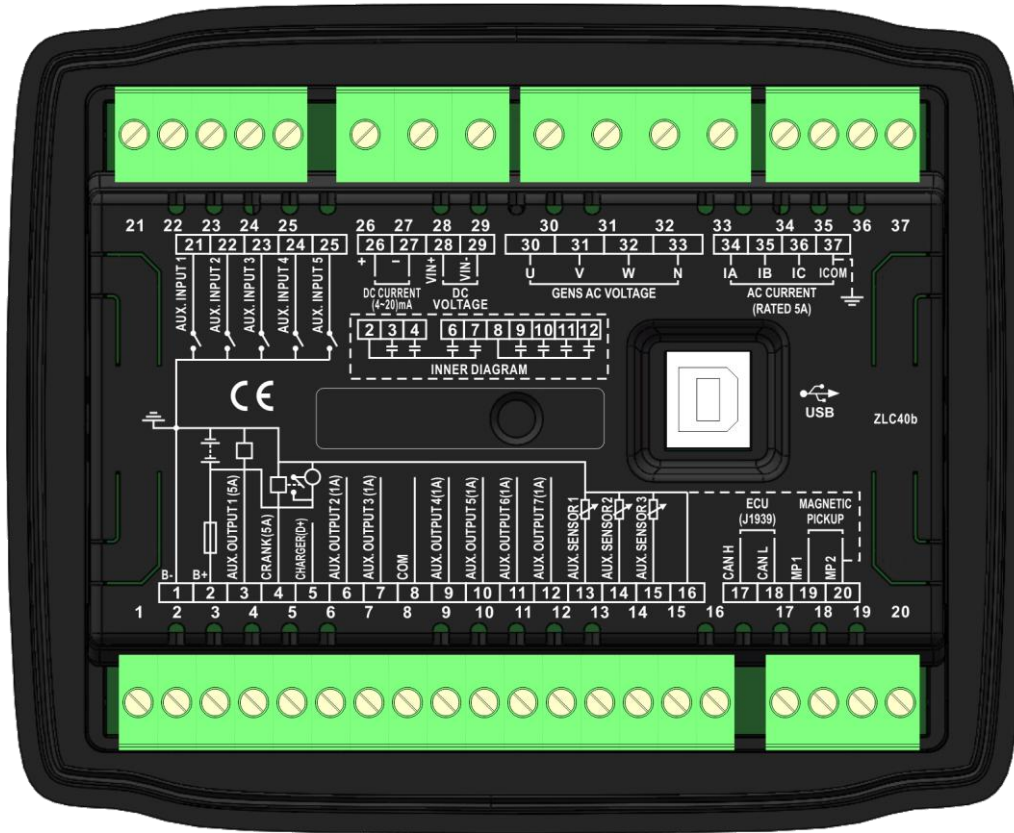

Fig.2 - ALC404 Controller Rear Panel Diagram

Table 17 - Terminal Connection Description

No.	Functions	Cable Size	Description
1	DC input B-	1.5 mm ²	DC power negative input and external connected with negative of starter battery.
2	DC input B+	1.5 mm ²	DC power positive input and external connected with positive of starter battery. If the length is above 30m, double wires need to be paralleled and 20A fuse is recommended.
3	Aux. Output 1	1.0 mm ²	B+ output is supplied by terminal No.2, rated 5A. If the fuel relay output needs to be connected, users can configure "Output 1 Settings" in "Relay Output Ports Setting" page.
4	Crank	1.0 mm ²	B+ output is supplied by terminal No.2, rated 5A.
5	Charger (D+)	1.0 mm ²	Connected with charger's D+ (WL) terminal. If no this terminal in charger, this terminal is hanging in the air.
6	Aux. output 2	1.0 mm ²	B+ output, rated 1A.
7	Aux. output 3	1.0 mm ²	
8	COM	1.0 mm ²	Terminal No. 9~No.12 correspond to common port



No.	Functions	Cable Size	Description
			of volt free relay; external connect with DC voltage.
9	Aux. Output 4	1.0 mm ²	Separately combined with terminal No. 8 as normally open contactor of relay with rated current 1A (voltage free output). Recommend enlarging the capacity of relay according to the load.
10	Aux. Output 5	1.0 mm ²	
11	Aux. Output 6	1.0 mm ²	
12	Aux. Output 7	1.0 mm ²	
13	Aux. Sensor 1	1.0 mm ²	It is programmable sensor.
14	Aux. Sensor 2	1.0 mm ²	It is programmable sensor.
15	Aux. Sensor 3	1.0 mm ²	It is programmable sensor.
16	Sensor COM GND	1.0 mm ²	Internal connect with B-, sensor common ground.
17	CAN H	0.5 mm ²	120Ω resistance is paralleled with CAN H and CAN L. Transceiver is non-isolated and shielded wire is recommended.
18	CAN L	0.5 mm ²	
19	Magnetic Sensor +	0.5mm ²	Connect to speed sensor.
20	Magnetic Sensor -	0.5mm ²	Connect to speed sensor. Internal has connected with B-.
21	Aux. Input 1	1.0 mm ²	Digital input port, which connected B- to activate.
22	Aux. Input 2	1.0 mm ²	Digital input port, which connected B- to activate.
23	Aux. Input 3	1.0 mm ²	Digital input port, which connected B- to activate.
24	Aux. Input 4	1.0 mm ²	Digital input port, which connected B- to activate.
25	Aux. Input 5	1.0 mm ²	Digital input port, which connected B- to activate.
26	DC Current Input +	1.0 mm ²	Connect to the output port of Hall DC 4-20mA sensor (DC generator current).
27	DC Current Input -	1.0 mm ²	
28	DC Voltage Input +	1.0 mm ²	Connect to output port of DC generator.
29	DC Voltage Input -	1.0 mm ²	
30	Genset U-phase Volt. Monitoring Input	1.0 mm ²	Connect to U-phase output port of genset (recommend 2A fuse).
31	Genset V-phase Volt. Monitoring Input	1.0 mm ²	Connect to V-phase output port of genset (recommend 2A fuse).
32	Genset W-phase Volt. Monitoring Input	1.0 mm ²	Connect to W-phase output port of genset (recommend 2A fuse).
33	Genset N-wire Input	1.0 mm ²	Connect to N-wire output port of genset.
34	CT A-phase Monitoring Input	1.5 mm ²	Externally connect to secondary coil of current transformer (max. 5A).
35	CT B-phase Monitoring Input	1.5 mm ²	Externally connect to secondary coil of current transformer (max. 5A).
36	CT C-phase Monitoring Input	1.5 mm ²	Externally connect to secondary coil of current transformer (max. 5A).
37	CT COM	1.5 mm ²	Common ground; Connect with negative of starter battery.
USB	USB Port		Communicate with PC software.

▲ NOTE: USB port in the rear of controller is communication port, which can realize controller programming and monitoring functions via PC software.



7 SCOPES AND DEFINITIONS OF PROGRAMMABLE PARAMETERS

7.1 AUTO START PARAMETER SETTINGS

Table 18 – Auto Start Parameter Settings

Parameters		Setting Range	Default	Remark
Timer Mode Select		(0~3)	00 Daily	00 Daily 01 Weekly 02 Monthly 03 Custom Week
Start Day Select	00 Daily	If select 00 Daily, no options to be chose.		
	01 Weekly	(0~6)	00 Sunday	00 Sunday 01 Monday 02 Tuesday 03 Wednesday 04 Thursday 05 Friday 06 Saturday
	02 Monthly	(1~31)	1	1~31
	03 Custom Week	If select 03 Custom Week, no options to be chose.		
Auto Run Timer Set	Start Time	00:00-23:59	18:30	Start Time hh:mm
	Run Duration	00:00-23:59	12:00	Run Duration hh:mm
Custom Sunday	Start Time	00:00-23:59	18:30	Start Time hh:mm
	Run Duration	00:00-23:59	12:00	Run Duration hh:mm
Custom Monday	Start Time	00:00-23:59	18:30	Start Time hh:mm
	Run Duration	00:00-23:59	12:00	Run Duration hh:mm
Custom Tuesday	Start Time	00:00-23:59	18:30	Start Time hh:mm
	Run Duration	00:00-23:59	12:00	Run Duration hh:mm
Custom Wednesday	Start Time	00:00-23:59	18:30	Start Time hh:mm
	Run Duration	00:00-23:59	12:00	Run Duration hh:mm
Custom Thursday	Start Time	00:00-23:59	18:30	Start Time hh:mm
	Run Duration	00:00-23:59	12:00	Run Duration hh:mm
Custom Friday	Start Time	00:00-23:59	18:30	Start Time hh:mm
	Run Duration	00:00-23:59	12:00	Run Duration hh:mm
Custom Saturday	Start Time	00:00-23:59	18:30	Start Time hh:mm
	Run Duration	00:00-23:59	12:00	Run Duration hh:mm
Sunset Start Delay		(-60)-(+60)min	0	Start delay(with “+”and ”-“options)
Sunrise Stop Delay		(-60)-(+60)min	0	Stop delay(with “+”and ”-“options)



7.2 GENERIC PARAMETER SETTINGS

Table 19 – Generic Parameter Settings

Category	Parameters	Range	Default	Description
Timers	Start Delay	(0~3600)s	5	It is time from remote start signal is active to genset started.
	Stop Delay	(0~3600)s	5	It is time from remote start signal is deactivated to genset stopped.
	Preheat Delay	(0~3600)s	0	It is pre-energized time of glow plug before starter is powered up.
	Cranking Time	(1~60)s	5	It is starter each power-up time.
	Crank Rest Time	(3~60)s	10	It is waiting time to repower-up when the engine starts fail.
	Safety On Time	(0~3600)s	10	During this time, alarms including low oil pressure, high temperature, under speed, gen under frequency, gen under voltage, and fail to charge are deactivated.
	Start Idle Time	(0~3600)s	10	It is genset idle running time while starting up.
	Warming Up Time	(0~3600)s	30	After generator entering into high speed running, it is warming up time before ramp-on load.
	Cooling Time	(0~36000)s	60	After genset ramp-off load, it is cooling time before genset stop.
	Stop Idle Time	(0~3600)s	10	It is genset idle running time while stopping.
ETS Hold Time	(0~3600)s	20	It is electromagnet power-down time when to sop.	
Wait Stop Time	(0~3600)s	30	When “ETS Solenoid Hold” time set as 0, it is time needed from idle delay expired to genset stop completely; when “ETS Solenoid Hold” time not set	



Category	Parameters	Range	Default	Description
				as 0, it is time from ETS solenoid hold expired to genset stop completely;
	Audible Alarm Time	(1~3600)s	30	It is audible alarm output time after the new alarm signal occurred.
	Lights On Interval	(1~300)s	2	It is time from lights of genset receive the turn on/off signals to actually turn on/off.
	Rise Speed Pulse Time	(0.1~30.0)s	0.1	It is rise speed pulse output time (output port configured as Rise Speed Pulse)
	Drop Speed Pulse Time	(0.1~30.0)s	0.1	It is drop speed pulse output time (output port configured as Drop Speed Pulse)
Engine	Engine Type	(00~39)	00 Conventional Engine	Default as conventional engine. When connect to J1939 engine, please select the corresponding engine model.
	SPN Version	(1~3)	Version 1	Version 1 Version 2 Version 3
	Flywheel Teeth	(10.0~300.0)	118.0	Flywheel teeth that installed on the engine, which is used for judging starter disconnect conditions and testing engine speed. Details to see the following installation instruction.
	Speed On Load	(0-100)%	90	The setting value is rated speed percentage, and controller detects while genset in ready for load stage. If speed bellows loading speed, genset will not enter into normal running stage.
	Rated Speed	(0~5999)r/min	1500	Provide standard for judging over /under speed



Category	Parameters	Range	Default	Description
				and loading speed.
	Enable Fast Loading Feature	(0~1)	0	0 Disabled 1 Enabled After fast loading enabled, engine starts and enters into stage of safety on delay, and if genset meet the requirements of loading condition, it will directly enter into ready for load stage.
	Start Attempts	(1-10)times	3	It is the maximum start attempts if genset fail to start. If the preset start attempts been reached, controller will send start fail signal.
	Disconnect Condition	(0~6)	3	AC genset reference to Table 25 <u>AC GENSET CRANK DISCONNECT CONDITION</u> ; DC genset reference to Table 26 <u>DC GENSET CRANK DISCONNECT CONDITION</u> . There are 3 conditions to make starter disconnected with engine, and they all can be used separately or simultaneously aiming to disconnect starter motor with engine as soon as possible.
	Disconnect Frequency	(0~200)%	30	The setting value is rated frequency pct. of genset. When genset frequency is above the setting limit, starter will disconnect. Details to see the following installation instructions.
	Disconnect Speed	(0~200)%	30	The setting value is rated speed pct. of genset. When genset speed is above the setting limit, starter will



Category	Parameters	Range	Default	Description	
				disconnect. Details to see the following installation instructions.	
	Disconnect Oil Pressure	(200~600)kPa	200	When genset oil pressure is above the setting limit, starter will disconnect. Details to see the following installation instructions.	
	Disconnect DC Voltage	(0~200)%	30	The setting value is rated voltage pct. of DC genset. When DC power voltage is above the setting limit, starter will disconnect. Details to see the following installation instructions.	
	Rated Starting Battery Voltage	(0~60.0)V	24.0	Provide standard for judging battery over/under voltage and charge fail.	
	Battery Charge Alternator Failure Warning	Enable	(0~1)	1	0 Disabled 1 Enabled
		Set Value	(0~200)%	75	The setting value is percentage of starting battery rated voltage. While genset in normal running stage, if D+(WL) voltage of charger bellows setting limit and delay time is expired, controller will send charge fail warning signal.
		Return	(0~200)%	78	The return value is percentage of starting battery rated voltage. If controller has sent charge fail warning signal, when D+(WL) voltage exceeds return value, charge fail warning will reset automatically.
		Delay	(0~3600)s	5	
	Battery Under Voltage Warning	Enable	(0~1)	1	0 Disabled 1 Enabled
		Set Value	(0~200)%	75	The setting value is percentage of starting battery rated voltage
Return		(0~200)%	80	The return value is	



Category	Parameters	Range	Default	Description	
				percentage of starting battery rated voltage	
		Delay	(0~3600)s	20	
	Battery Over Voltage Warning	Enable	(0~1)	1	0 Disabled 1 Enabled
		Set Value	(0~200)%	125	The setting value is percentage of starting battery rated voltage
		Return	(0~200)%	120	The return value is percentage of starting battery rated voltage
		Delay	(0~3600)s	20	
	Under Starting Battery Voltage Start Set	Work Mode Select	(0~3)	0	0 Invalid 1 Auto Mode Active 2 Manual Mode Active 3 Auto and Manual Mode Active
		Max. Run Time	(0.1~100.0)h	4.0	If battery under voltage starts up, when charging time exceeds the setting limit, engine will automatically shut down, and then charging will stop.
		Full Charge Delay	(0~1000)min	60	It is the time from battery voltage exceeds full charged voltage limit to under voltage start end.
		Start Value	(0~200)%	80	The setting value is percentage of starting battery rated voltage. When controller detects that genset in standby status and battery voltage bellows under voltage start limit, it will execute auto under voltage start logic.
		Full Charge Value	(0~200)%	125	The setting value is percentage of starting battery rated voltage. When controller detects that genset in under voltage start maintenance status and genset is normal running, if battery voltage



Category	Parameters	Range	Default	Description
				exceeds full charged limit, controller will start trickle charging countdown.
	Under Battery Voltage Start Delay	(0~3600)s	30	It is the time from controller detects battery under voltage start signal to genset starts up, or time from battery under voltage start charging completely to genset ready to stop.
	Under Battery Volt. Start On Load	(0~1)	0	0 Disabled 1 Enabled If enabled, genset under voltage start allows ramp-on load, otherwise, only charging function is permitted and lights are off.
Under Speed Shutdown	Enable	(0~1)	1	0 Disabled 1 Enabled
	Set Value	(0~200)%	80	The setting value is percentage of rated speed.
	Delay	(0~3600)s	10	
Over Speed Shutdown	Enable	(0~1)	1	0 Disabled 1 Enabled
	Set Value	(0~200)%	114	The setting value is percentage of rated speed.
	Delay	(0~3600)s	2	
Under Speed Warning	Enable	(0~1)	0	0 Disabled 1 Enabled
	Set Value	(0~200)%	86	The setting value is percentage of rated speed.
	Return Value	(0~200)%	90	The setting value is percentage of rated speed.
	Delay	(0~3600)s	3	
Over Speed Warning	Enable	(0~1)	0	0 Disabled 1 Enabled
	Set Value	(0~200)%	110	The setting value is percentage of rated speed.
	Return Value	(0~200)%	108	The setting value is percentage of rated speed.
	Delay	(0~3600)s	5	
Loss of Speed Signal	Action	(1~2)	1	1 Warning 2 Shutdown
	Delay	(0~3600)s	5	It is time from controller detects that speed is 0 to action confirmed.
Overshoot	Set Value	(0~20)%	10	If set as 0%, which means this function is disabled.
	Delay	(0~3600) s	2	



Category	Parameters	Range	Default	Description	
	Note: this function is only active in safety running period. This moment, over speed shutdown delay is overshoot delay, and calculation formula of speed limit is $\text{speed limit} = \text{rated speed} * \text{over speed \%} * (1 + \text{overshoot \%})$.				
	Fuel Pump Control	Enable	(0~1)	0	0 Disabled 1 Enabled
		Turn On	(0~1000)%	10	If fuel level bellows turn on limit, output port of fuel pump control starts output.
		Turn Off	(0~1000)%	80	If fuel level exceeds turn off limit, output port of fuel pump control stops output.
		Max. Time(Turn On)	(0~3600)s	60	It is the maximum output time of fuel pump control, aiming to prevent fuel pump continues working because of the sensor fault.
	Fuel Tank Capacity	Enable	(0~1)	0	0 Disabled 1 Enabled
		Capacity	(0~10000)L	100	After it is enabled, liquid unit displayed on the mains screen is changed from % to L. conversion formula: Fuel capacity = tank capacity * fuel level
		Coolant Temperature Associated	(0~3)	1	0 Not Associated
		Oil Pressure Associated	(0~3)	2	1 ALC404 Sensor 1 2 ALC404 Sensor 2 3 ALC404 Sensor 3 Note: if select engine with ECU, this parameter is invalid, and coolant temp. and oil pressure data displayed on controller main screen are transferred by ECU.
		Fuel Level Associated	(0~3)	3	0 Not associated 1 ALC404 Sensor 1 2 ALC404 Sensor 2 3 ALC404 Sensor 3
Generator	Generator Type	(0~4)	0	0 3Phase, 4Wire(3P4W) 1 3Phase, 3Wire(3P3W) 2 1Phase, 2Wire(1P2W) 3 2Phase, 3Wire(2P3W) 4 DC Power	
		Enabled	(0~1)	0 Disabled 1 Enabled	



Category	Parameters	Range	Default	Description	
	DC Genset Check AC Set	AC System	(0~3)	0	0 3Phase, 4Wire(3P4W) 1 3Phase, 3Wire(3P3W) 2 1Phase, 2Wire(1P2W) 3 2Phase, 3Wire(2P3W)
	Note: if users select power supply type as 4 DC Power, meanwhile, crank disconnect conditions include speed, when this function is enabled, controller will collect AC parameters based on the AC system of DC genset and coordinate with poles of genset to calculate engine speed.(speed sensor cannot connected)				
	Generator Poles		(2~64)	4	Generator poles only can be set as an even number, which use to calculate engine speed if there is no speed sensor installed.
	Generator Rated Voltage		(10~1000)V	230	Provide standard for judging generator over/under voltage and loading voltage. If voltage transformer is used, it is PT primary voltage. If AC system set as 3P3W, it is line voltage; and if other AC system is selected, it is phase voltage.
	Generator Rated Frequency		(10.0~600.0) Hz	50.0	Provide standard for judging generator over/under frequency and loading frequency.
	Generator Voltage On Load		(0~200)%	85	The setting limit is percentage generator rated voltage. Controller detects unit while genset in ready for load stage, if voltage bellows loading voltage, genset will not enter into normal running status.
Generator Frequency On Load		(0~200)%	90	The setting limit is percentage generator rated frequency. Controller detects unit while genset in ready for load stage, if frequency bellows loading	



Category	Parameters	Range	Default	Description
				frequency, genset will not enter into normal running status.
Voltage Transformer(PT)	Enable	(0~1)	0	0 Disabled 1 Enabled
	PT Primary	(10~1000)V	110	
	PT Secondary	(10~1000)V	110	
Gen. Under Voltage Shutdown	Enable	(0~1)	1	0 Disabled 1 Enabled
	Set Value	(0~200)%	80	The setting limit is percentage of generator rated voltage.
	Delay	(0~3600)s	10	
Gen. Over Voltage Shutdown	Enable	(0~1)	1	0 Disabled 1 Enabled
	Set Value	(0~200)%	120	The setting limit is percentage of generator rated voltage.
	Delay	(0~3600)s	5	
Gen. Under Frequency Shutdown	Enable	(0~1)	1	0 Disabled 1 Enabled
	Set Value	(0~200)%	80	The setting limit is percentage of generator rated frequency.
	Delay	(0~3600)s	10	
Gen Over Frequency Shutdown	Enable	(0~1)	1	0 Disabled 1 Enabled
	Set Value	(0~200)%	114	The setting limit is percentage of generator rated frequency.
	Delay	(0~3600)s	3	
Gen Under Voltage Warning	Enable	(0~1)	1	0 Disabled 1 Enabled
	Set Value	(0~200)%	84	The setting limit is percentage of generator rated voltage.
	Return	(0~200)%	86	The setting limit is percentage of generator rated voltage.
	Delay	(0~3600)s	5	
Gen Over Voltage Warning	Enable	(0~1)	1	0 Disabled 1 Enabled
	Set Value	(0~200)%	110	The setting limit is percentage of generator rated voltage.
	Return	(0~200)%	108	The setting limit is percentage of generator rated voltage.
	Delay	(0~3600)s	3	



Category	Parameters	Range	Default	Description	
	Gen. Under Frequency Warning	Enable	(0~1)	1	0 Disabled 1 Enabled
		Set Value	(0~200)%	84	The setting limit is percentage of generator rated frequency.
		Return	(0~200)%	86	The setting limit is percentage of generator rated frequency.
		Delay	(0~3600)s	5	
	Gen Over Frequency Warning	Enable	(0~1)	1	0 Disabled 1 Enabled
		Set Value	(0~200)%	110	The setting limit is percentage of generator rated frequency.
		Return	(0~200)%	108	The setting limit is percentage of generator rated frequency.
		Delay	(0~3600)s	3	
Mains	Mains Supply Type	(0~4)	0	0 3Phase 4Wire(3P4W) 1 3Phase 3Wire (3P3W) 2 1Phase 2Wire (1P2W) 3 2Phase 3Wire (2P3W) 4 DC Power	
	Mains Rated Voltage	(10~1000)V	230	Provide standard for judging mains over/under voltage. If voltage transformer is used, it is PT primary voltage.If AC system set as 3P3W, it is line voltage; and if other AC system is selected, it is phase voltage.	
	Mains Rated Frequency	(10.0~600.0)Hz	50.0	Provide standard for judging mains over/under frequency.	
	Mains Normal Delay	(0~3600)s	10	It is delay time to confirm mains normal.	
	Mains Abnormal Delay	(0~3600)s	5	It is delay time to confirm mains abnormal.	
	Voltage Transformer (PT)	Enable	(0~1)	0	0 Disabled 1 Enabled
		PT Primary	(10~1000)V	110	
		PT Secondary	(10~1000)V	110	
	Mains Under Voltage Warning	Enable	(0~1)	1	0 Disabled 1 Enabled
		Set Value	(0~200)%	80	The setting limit is



Category	Parameters		Range	Default	Description
					percentage of mains rated voltage.
		Return	(0~200)%	84	The setting limit is percentage of mains rated voltage.
		Delay	(0~3600)s	5	
	Mains Over Voltage Warning	Enable	(0~1)	1	0 Disabled 1 Enabled
		Set Value	(0~200)%	120	The setting limit is percentage of mains rated voltage.
		Return	(0~200)%	116	The setting limit is percentage of mains rated voltage.
		Delay	(0~3600)s	5	
	Mains Under Frequency Warning	Enable	(0~1)	1	0 Disabled 1 Enabled
		Set Value	(0~200)%	90	The setting limit is percentage of mains rated frequency.
		Return	(0~200)%	94	The setting limit is percentage of mains rated frequency.
		Delay	(0~3600)s	5	
	Mains Over Frequency Warning	Enable	(0~1)	1	0 Disabled 1 Enabled
		Set Value	(0~200)%	114	The setting limit is percentage of mains rated frequency.
		Return	(0~200)%	110	The setting limit is percentage of mains rated frequency.
		Delay	(0~3600)s	5	
	Load	CT Ratio/Hall DC Sensor Spec.	CT Ratio	(5~6000)/5	500
Hall DC Sensor Spec.			(5~6000)A	500	
Rated Current		(5~6000)A	500	It is the rated current of generator, and used for calculating over current of	



Category	Parameters	Range	Default	Description	
				load.	
	Light Amount Config.	(1~4)	4	Number of lights that the system can control effectively.	
	Single Light Rated Current	(0.01~99.99)A	4.00	Rated current consumption for each light, which is used to provide standard for judging light fault.	
	Over Current Protection Configure	Enable	(0~1)	1	0 Disabled 1 Enabled
		Set Value	(0~200)%	120	The setting value is the percentage of rated full-load current.
		Action	(1~3)	3	1 Warning 2 Shutdown 3 Trip and Stop
		Time Multiplier	(1~36)	36	The calculate formula of over current delay can reference to 7.12 <u>OVER CURRENT ACTION</u>
	Light Fault Check Configure	Enable	(0~1)	0	0 Disabled 1 Enabled
		Single Light Fault	(0~200)%	75	It is the percentage of rated current for each light.
		Delay	(0~3600)s	5	It is delay time used to confirm light fault.
		Light Fault Action	(0~3)	1	0 No Action 1 Warning 2 Shutdown 3 Smart Action Note: Smart action means controller will prior ensure lights of tower works normal, if all lights are fault, controller will shutdown the unit, otherwise, controller only alarms.
	Low Fuel Level Reduce Light Amount	Enable	(0~1)	0	0 Disabled 1 Enabled
		Reduce Light-on Amount Level	(0~1000)%	20	While genset is normal running, when fuel level bellows the setting limit, controller will send fuel level drop turn off the light warning signal. Then controller auto adjust the



Category	Parameters		Range	Default	Description	
					max. number of turned on lights that allowed to number of lights that allowed in this mode.	
	Recover Light-on Amount Level		(0~1000)%	25	While genset is normal running, when fuel level exceeds the setting limit after controller sent fuel level drop turn off the light warning signal, the number of turned on lights allowed return to the pre-set total lights.	
	Delay		(0~3600)s	30	It is delay time to confirm that fuel level drop turn off the light warning.	
	Allowed Light-on Amount		(0~4)	1	The number of turned on lights that allowed after controller sending fuel level drop turn off the light signal.	
	<p>▲Note: This function is invalid when mains power supply is active or fuel level does not associate with sensors.</p>					
Sensors	Flexible Sensor 1		Details please to see 7.3 FLEXIBLE SENSOR 1 SETTINGS			
	Flexible Sensor 2		Details please to see 7.4 FLEXIBLE SENSOR 2 SETTINGS			
	Flexible Sensor 3		Details please to see 7.5 FLEXIBLE SENSOR 3 SETTINGS			
	ECU Coolant Temperature	High Shutdown	Enable	(0~1)	1	0 Disabled 1 Enabled
			Set Value	(0~300)°C	98	
			Delay	(0~3600)s	3	
		High Warning	Enable	(0~1)	1	0 Disabled 1 Enabled
	Set Value		(0~300)°C	95		
	Return Value		(0~300)°C	93		
	Delay		(0~3600)s	5		
ECU Oil Pressure	Low Shutdown	Enable	(0~1)	1	0 Disabled 1 Enabled	
		Set Value	(0~1000)kPa	103		



Category	Parameters		Range	Default	Description
	Low Warning	Delay	(0~3600)s	3	
		Enable	(0~1)	1	0 Disabled 1 Enabled
		Set Value	(0~1000)kPa	124	
		Return Value	(0~1000)kPa	138	
		Delay	(0~3600)s	5	
<p>▲NOTE: Parameters of ECU_coolant temperature and ECU_oil pressure, only available for EFI genset, are used for judging alarm situation of coolant temperature and oil pressure that returned from ECU.</p>					
Digital Inputs	Input 1 Set	Function Config.	(0~59)	04 Remote Start	Functions please to see 7.9 FUNCTION DEFINITION OF INPUT PORTS.
		Active	(0~1)	0 Close to activate 1 Open to activate	0 Close to activate 1 Open to activate
	Input 2 Set	Function Config.	(0~59)	08 1#Light Feedback	Functions please to see 7.9 FUNCTION DEFINITION OF INPUT PORTS.
		Active	(0~1)	0 Close to activate 1 Open to activate	0 Close to activate 1 Open to activate
	Input 3 Set	Function Config.	(0~59)	09 2#Light Feedback	Functions please to see 7.9 FUNCTION DEFINITION OF INPUT PORTS.
		Active	(0~1)	0 Close to activate 1 Open to activate	0 Close to activate 1 Open to activate
	Input 4 Set	Function Config.	(0~59)	10 3#Light Feedback	Functions please to see 7.9 FUNCTION DEFINITION OF INPUT PORTS.
		Active	(0~1)	0 Close to activate 1 Open to activate	0 Close to activate 1 Open to activate
	Input 5 Set	Function Config.	(0~59)	11 4#Light Feedback	Functions please to see 7.9 FUNCTION DEFINITION OF INPUT PORTS.
		Active	(0~1)	0 Close to activate 1 Open to activate	0 Close to activate 1 Open to activate
Relay Outputs	Output 1 Set	Function Config.	(0~119)	09 Fuel Relay Output	Functions please to see 7.11 FUNCTION DEFINITION OF OUTPUT PORTS.
		Output Type	(0~1)	0 Open 1 Close	0 Open 1 Close
	Output 2 Set	Function Config.	(0~119)	035 Energize to Stop	7.11 FUNCTION DEFINITION OF OUTPUT PORTS.



Category	Parameters		Range	Default	Description	
		Output Type	(0~1)	0 Open	0 Open 1 Close	
	Output 3 Set	Function Config.	(0~119)	22 Common Shutdown	<u>7.11 FUNCTION DEFINITION OF OUTPUT PORTS.</u>	
		Output Type	(0~1)	0 Open	0 Open 1 Close	
	Output 4 Set	Function Config.	(0~119)	106 1#Light Output	<u>7.11 FUNCTION DEFINITION OF OUTPUT PORTS.</u>	
		Output Type	(0~1)	0 Open	0 Open 1 Close	
	Output 5 Set	Function Config.	(0~119)	107 2#Light Output	<u>7.11 FUNCTION DEFINITION OF OUTPUT PORTS.</u>	
		Output Type	(0~1)	0 Open	0 Open 1 Close	
	Output 6 Set	Function Config.	(0~119)	108 3#Light Output	<u>7.11 FUNCTION DEFINITION OF OUTPUT PORTS.</u>	
		Output Type	(0~1)	0 Open	0 Open 1 Close	
	Output 7 Set	Function Config.	(0~119)	109 4#Light Output	<u>7.11 FUNCTION DEFINITION OF OUTPUT PORTS.</u>	
		Output Type	(0~1)	0 Open	0 Open 1 Close	
	Module Config.	Language Select		(0~1)	0	0 Simplified Chinese 1 English
		Power On Mode		(0~4)	0	0 Stop Mode 1 Manual Mode 2 Auto Timer Mode 3 Sunrise/Sunset Mode 4 Remote Start Mode
		Password Config		(0~65533)	00318	"00318" password is used to enter into advanced parameter settings.
Start Interface		Enable	(0~1)	0	0 Disabled 1 Enabled	
		Start Interface Delay	(0~3600)s	3	After enabled, it is the boot screen duration that user defined for each start.	
Deep Sleep		Enable	(0~1)	0	0 Disabled 1 Enabled	
	Deep Sleep	(1~100)min	6	After enabled, no keys been		



Category	Parameters		Range	Default	Description
		Delay			pressed before the delay expired is one condition for judging whether controller enters into deep sleep mode.

▲ NOTE: The remaining parameters can only be configured by the PC software.

7.3 FLEXIBLE SENSOR 1 SETTINGS

Table 20 – Flexible Sensor 1 Parameter Settings

No.	Parameter		Range	Default	Description
1	Sensor Type		(0~3)	1	0 Not Used 1 Temp. Sensor 2 Pressure Sensor 3 Fuel Level Sensor
2	Curve Type		(0~15)	11	Details of sensor curve please to see 7.6 SENSOR CURVE SELECTION.
3	Open Circuit Action		(0~2)	0	0 Warning 1 Shutdown 2 No Action
4	Display Unit		(0~1)	0	0: °C 1: °F
5	Sensor High Shutdown	(0~1)	(0~1)	1	0 Disabled 1 Enabled
6		Set Value	(0~1000)°C	98	
7		Delay	(0~3600)s	3	
8	Sensor Low Shutdown	Enable	(0~1)	0	0 Disabled 1 Enabled
9		Set Value	(0~1000)°C	0	
10		Delay	(0~3600)s	3	
11	Sensor High Warning	Enable	(0~1)	1	0 Disabled 1 Enabled
12		Set Value	(0~1000)°C	95	
13		Return Value	(0~1000)°C	93	
14		Delay	(0~3600)s	5	
15	Sensor Low Warning	Enable	(0~1)	0	0 Disabled 1 Enabled
16		Set Value	(0~1000)°C	70	
17		Return Value	(0~1000)°C	75	
18		Delay	(0~3600)s	5s	
19	User-defined Sensor Curve	1 st point X (Resistance)	(0~1000)	0	Sensor curves can be user defined. X-axis and Y-axis separately contains 8 points. Unit of X-axis is Ω; Units of Y-axis are as
20		2 nd point X (Resistance)	(0~1000)	21	
21		3 rd point X (Resistance)	(0~1000)	28	



No.	Parameter	Range	Default	Description
22	4 th point X (Resistance)	(0~1000)	39	follows: pressure type: kPa Fuel level type: % Temperature type: °C
23	5 th point X (Resistance)	(0~1000)	56	
24	6 th point X (Resistance)	(0~1000)	116	
25	7 th point X (Resistance)	(0~1000)	258	
26	8 th point X (Resistance)	(0~1000)	300	
27	1 st point Y(Value)	(0~4000)	140	
28	2 nd point Y(Value)	(0~4000)	110	
29	3 rd point Y(Value)	(0~4000)	100	
30	4 th point Y(Value)	(0~4000)	90	
31	5 th point Y(Value)	(0~4000)	80	
32	6 th point Y(Value)	(0~4000)	60	
33	7 th point Y(Value)	(0~4000)	40	
34	8 th point Y(Value)	(0~4000)	20	
35	User-defined Strings	User-defined sensor name	Chinese: 发动机温度 English: Engine Temp.	

7.4 FLEXIBLE SENSOR 2 SETTINGS

Table 21 – Flexible Sensor 2 Settings

No.	Parameter	Range	Default	Description	
1	Sensor Type	(0~3)	2	0 Not Used 1 Temp. Sensor 2 Pressure Sensor 3 Fuel Level Sensor	
2	Curve Type	(0~15)	13	Details of sensor curve please to see 7.6 SENSOR CURVE SELECTION.	
3	Open Circuit Action	(0~2)	0	0 Warning 1 Shutdown 2 No Action	
4	Display Unit	(0~2)	0	0: kPa 1: bar 2: psi	
5	Sensor High Shutdown	Enable	(0~1)	0	0 Disabled 1 Enabled
6		Set Value	(0~1000)kPa	0	
7		Delay	(0~3600)s	3	



No.	Parameter	Range	Default	Description	
8	Sensor Low Shutdown	Enable	(0~1)	1	0 Disabled 1 Enabled
9		Set Value	(0~1000)kPa	103	
10		Delay	(0~3600)s	3	
11	Sensor High Warning	Enable	(0~1)	0	0 Disabled 1 Enabled
12		Set Value	(0~1000)kPa	0	
13		Return Value	(0~1000)kPa	0	
14		Delay	(0~3600)s	5	
15	Sensor Low Warning	Enable	(0~1)	1	0 Disabled 1 Enabled
16		Set Value	(0~1000) kPa	124	
17		Return Value	(0~1000) kPa	138	
18		Delay	(0~3600)s	5	
19	User-defined Sensor Curve	1 st point X (Resistance)	(0~1000)	15	X-axis and Y-axis of user defined sensor curves are all with 8 points, Unit of X-axis is Ω, Units of X-axis are as follows: Pressure: kPa Fuel Level: % Temp.: °C
20		2 nd point X (Resistance)	(0~1000)	30	
21		3 rd point X (Resistance)	(0~1000)	50	
22		4 th point X (Resistance)	(0~1000)	86	
23		5 th point X (Resistance)	(0~1000)	100	
24		6 th point X (Resistance)	(0~1000)	132	
25		7 th point X (Resistance)	(0~1000)	168	
26		8 th point X (Resistance)	(0~1000)	200	
27		1 st point Y(Value)	(0~4000)	0	
28		2 nd point Y(Value)	(0~4000)	100	
29		3 rd point Y(Value)	(0~4000)	200	
30		4 th point Y(Value)	(0~4000)	400	
31		5 th point Y(Value)	(0~4000)	500	
32		6 th point Y(Value)	(0~4000)	700	
33		7 th point Y(Value)	(0~4000)	1000	
34		8 th point Y(Value)	(0~4000)	1000	
35	User-defined Strings	User-defined sensor name	Chinese: 机油压力 English: Oil Pressure	PC software can write 10 Chinese characters and 20 English characters.	



7.5 FLEXIBLE SENSOR 3 SETTINGS

Table 22 – Flexible Sensor 3 Settings

No.	Parameter	Range	Default	Description	
1	Sensor Type	(0~3)	3	0 Not Used 1 Temp. Sensor 2 Pressure Sensor 3 Fuel Level Sensor	
2	Curve Type	(0~15)	11	Details of sensor curve please to see <u>7.6 SENSOR CURVE SELECTION.</u>	
3	Open Circuit Action	(0~2)	0	0 Warning 1 Shutdown 2 No Action	
4	Display Unit	0	0	0: %	
5	Sensor High Shutdown	Enable	(0~1)	0	0 Disabled 1 Enabled
6		Set Value	(0~1000)%	0	
7		Delay	(0~3600)s	3	
8	Sensor Low Shutdown	Enable	(0~1)	0	0 Disabled 1 Enabled
9		Set Value	(0~1000)%	0	
10		Delay	(0~3600)s	3	
11	Sensor High Warning	Enable	(0~1)	0	0 Disabled 1 Enabled
12		Set Value	(0~1000)%	0	
13		Return Value	(0~1000)%	0	
14		Delay	(0~3600)s	5	
15	Sensor Low Warning	Enable	(0~1)	1	0 Disabled 1 Enabled
16		Set Value	(0~1000)%	10	
17		Return Value	(0~1000)%	15	
18		Delay	(0~3600)s	10	
19	User-defined Sensor Curve	1 st point X (Resistance)	(0~1000)	0	X-axis and Y-axis of user defined sensor curve are all with 8 points, Unit of X-axis is Ω , Units of X-axis are as follows: Pressure: kPa Fuel Level: % Temp.: °C
20		2 nd point X (Resistance)	(0~1000)	20	
21		3 rd point X (Resistance)	(0~1000)	40	
22		4 th point X (Resistance)	(0~1000)	80	
23		5 th point X (Resistance)	(0~1000)	100	
24		6 th point X (Resistance)	(0~1000)	120	
25		7 th point X (Resistance)	(0~1000)	160	



No.	Parameter	Range	Default	Description
26	8 th point X (Resistance)	(0~1000)	200	
27	1 st point Y(Value)	(0~4000)	0	
28	2 nd point Y(Value)	(0~4000)	10	
29	3 rd point Y(Value)	(0~4000)	20	
30	4 th point Y(Value)	(0~4000)	40	
31	5 th point Y(Value)	(0~4000)	50	
32	6 th point Y(Value)	(0~4000)	60	
33	7 th point Y(Value)	(0~4000)	80	
34	8 th point Y(Value)	(0~4000)	100	
35	User-defined Strings	User-defined sensor name	Chinese: 燃油液位 English: Fuel Level	PC software can write 10 Chinese characters and 20 English characters.

7.6 SENSOR CURVE SELECTION

Table 23 – Sensor Curves

No.	Items	Content	Remark
1	Temperature Sensor	0 Not Used 1 Digital closed for high temperature 2 Digital open for high temperature 3 User defined 4 VDO 120 degrees C 5 Datcon high 6 Datcon low 7 SGX 120 degrees C 8 Cummins 9 SGH 120 degrees C 10 Curtis 11 SGD 120 degrees C 12 Pt100 13 Reserved 14 Reserved 15 Reserved	The range of user-defined resistor type sensor is (0-999.9) Ω; factory default is 11 SGD 120 degrees C curve. User defined sensor curve can be set via PC software.
2	Oil pressure Sensor	0 Not Used 1 Digital closed for low pressure 2 Digital open for low pressure 3 User defined 4 VDO 5 bar 5 VDO 10 bar 6 Datcon 5 bar 7 Datcon 10 bar 8 Datcon 7 bar	The range of user-defined resistor type sensor is (0-999.9) Ω; factory default is 13 SGD 10 bar sensor curve. User defined sensor curve can be set via utility software.



No.	Items	Content	Remark
		9 SGX 10 bar 10 CMB812 11 SGH 10 bar 12 Curtis 13 SGD 10 bar 14 Reserved 15 Reserved	
3	Fuel Level Sensor	0 Not Used 1 Digital close for low fuel level 2 Digital open for low fuel level 3 User defined 4 VDO Ohm range (10-180) 5 VDO Tube type (90-0) 6 US Ohm range (240-33) 7 GM Ohm range (0-90) 8 GM Ohm range Ohm range (0-30) 9 Ford (73-10) 10 NKZR12/24-1-04 Ohm range (100-0) 11 SGD 12 SGH 13 Reserved 14 Reserved 15 Reserved	The range of user-defined resistor type sensor is (0-999.9) Ω ; by default 11 SGD sensor curve is selected. User defined sensor curve can be set via utility software.



7.7 SENSOR SETTING

When reselect sensors, the sensor curve will be transferred into the standard value. For example, if factory default set as temperature sensor is SGX (120°C resistor type), its sensor curve is SGX (120°C resistor type); if select the SGD (120°C resistor type), the temperature sensor curve is SGD curve.

When there is difference between standard sensor curves and using sensor, user can adjust it in “curve type”.

When user defined the sensor curve, X value (resistor) must be input from small to large, otherwise, mistake occurs.

If select sensor type or sensor curve select as “Not Used”, sensor curve is not working.

The headmost or backmost values in the vertical coordinates can be set as same as below,

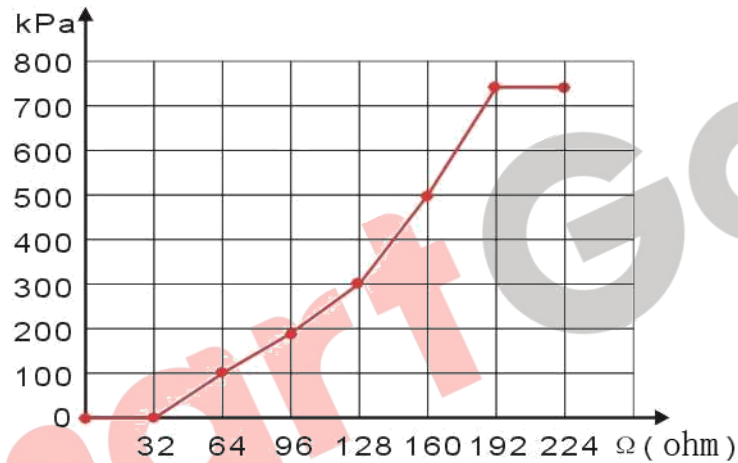

Fig. 3 – User Defined Sensor Curve Diagram

Table 24 - Normal Pressure Unit Conversion Form

Item	N/m ² / pa	kgf/cm ²	bar	1b/in ² .psi
1Pa	1	1.02x10 ⁻⁵	1x10 ⁻⁵	1.45x10 ⁻⁴
1kgf/cm ²	9.8x10 ⁴	1	0.98	14.2
1bar	1x10 ⁵	1.02	1	14.5
1psi	6.89x10 ³	7.03x10 ⁻²	6.89x10 ⁻²	1



7.8 CONDITIONS OF CRANK DISCONNECT SELECTION

Table 25 – AC Generator Crank Disconnect Conditions

No.	Contents
0	Gen frequency
1	Speed
2	Speed + Gen frequency
3	Oil pressure
4	Oil pressure + Gen frequency
5	Oil pressure + Speed
6	Oil pressure + Speed + Gen frequency

Table 26 – DC Generator Crank Disconnect Conditions

No.	Contents
0	DC Voltage
1	Speed
2	Speed + DC Voltage
3	Oil pressure
4	Oil pressure + DC Voltage
5	Oil pressure + Speed
6	Oil pressure + Speed + DC Voltage







▲NOTE:

- a) There are 3 conditions to make starter separate with engine; speed, generator frequency and oil pressure can be used separately while oil pressure suggest be used together with speed and generator frequency. The aim is to disconnect the starter motor as soon as possible.
- b) Speed is the real time speed collected by the speed sensor, and speed sensor is the magnetic equipment which be installed in starter for detecting flywheel teeth.
- c) When set as speed, must ensure that the number of flywheel teeth is as same as setting, otherwise, “over speed shutdown” or “under speed shutdown” may be caused.
- d) If genset without speed sensor please don’t select corresponding items, otherwise, “start fail” or “loss speed signal” maybe caused.
- e) If genset without oil pressure sensor, please don’t select corresponding items.
- f) If not select speed in crank disconnect setting, the engine speed displayed in controller is converted by the generator frequency and generator poles.
- g) For DC genset, changing “Gen frequency” of crank disconnect condition to “DC gen voltage”.



7.9 FUNCTION DEFINITION OF INPUT PORTS

Table 27 – Functions of Input Ports

No.	Type	Description
0	Not Used	
1	User Configured	Alarm types can be set by users. Details of setting content please to see <u>7.10 DEFINITION OF PROGRAMMABLE INPUT PORTS 1-5.</u>
2	Alarm Mute	When the input is active, audible alarms of output configuration will be inhibited and icon  will display on the rightmost of genset status line of main screen on the panel LCD.
3	Alarm Reset	When the input pulse is active (jog), it can reset shutdown alarms and trip and stop alarms.
4	Remote Start	In AUTO mode, when input is active, genset can be started automatically by controller and take on load when normal running. When input is deactivated, genset will be stopped automatically by controller.
5	Lamp Test	Test whether indicator lamps on the panel are normal or not when input is active (Lamp test).
6	Panel Lock	When the input is active, in addition to  ,  and  , other keys are unavailable (inhibit setting parameters through ) , simultaneously,  will be displayed on the rightmost of the genset status line of main screen on the panel LCD.
7	Reserved	
8	1#Light Feedback Input	When the input is active, the corresponding light of the lighting tower set through the feedback input method to access the controller to participate in automatic control. Details of control method please to see <u>7.13 LIGHT INPUT CONTROL MODE.</u>
9	2# Light Feedback Input	
10	3# Light Feedback Input	
11	4# Light Feedback Input	
12	Reserved	
13	1#Light Control Input	When the input is active, the corresponding light of the lighting tower set through the control input method to access the controller to participate in control. Details of control method please to see <u>7.13 LIGHT INPUT CONTROL MODE.</u>
14	2# Light Control Input	
15	3# Light Control Input	
16	4# Light Control Input	
17	Reserved	
18	1#Light Major Control	When the input is active, the corresponding light of the lighting tower set through the absolute control input method to access the controller to participate in control. Details of control method please to see <u>7.13 LIGHT INPUT CONTROL MODE.</u>
19	2# Light Major Control	
20	3# Light Major Control	
21	4# Light Major Control	
22	Reserved	
23	Emergency Stop	If the signal is active, genset will shut down immediately.
24	Reserved	
25	High Temp. Shutdown	If the signal is active after safety on delay expired, genset will immediate shutdown and controller initiate shutdown alarms.
26	Low Oil Pressure	If the signal is active after safety on delay expired, genset will



No.	Type	Description
	Shutdown	immediate shutdown and controller initiate shutdown alarms.
27	Low Fuel Level Shutdown	If the signal is active after safety on delay expired, genset will immediate shutdown and controller initiate shutdown alarms.
28	Low Coolant Level Shutdown	If the signal is active after safety on delay expired, genset will immediate shutdown and controller initiate shutdown alarms.
29	Oil Pressure Open Circuit Shutdown	If the signal is active after safety on delay expired, genset will immediate shutdown and controller initiate shutdown alarms.
30	Temp. Open Circuit Shutdown	If the signal is active after safety on delay expired, genset will immediate shutdown and controller initiate shutdown alarms.
31	Reserved	
32	Reserved	
33	Reserved	
34	Reserved	
35	Reserved	
36	Reserved	
37	Reserved	
38	Reserved	
39	High Temp. Warning Input	It is connect with digital input port of sensor, when the input is active, controller will initiate warning alarms.
40	Low Oil Pressure Warning	It is connect with digital input port of sensor, when the input is active, controller will initiate warning alarms.
41	Low Fuel Level Warning	It is connect with digital input port of sensor, when the input is active, controller will initiate warning alarms.
42	Low Coolant Level Warning	It is connect with digital input port of sensor, when the input is active, controller will initiate warning alarms.
43	High Canopy Temp. Warning	It is connect with digital input port of sensor, when the input is active, controller will initiate warning alarms.
44	Reserved	
45	Reserved	
46	Reserved	
47	Reserved	
48	Reserved	
49	External Charge Fail	It is connect with charge fail alarm output port of external charger, when the input is active, controller will initiate warning alarms.
50	Idle Speed Active	When the input is active, idle speed control starts output. Meanwhile, generator under voltage/under frequency/ under speed it not protected.
51	Rise Speed Pulse(ECU)	It is used for EFI engine with CANBUS.
52	Drop Speed Pulse(ECU)	It is used for EFI engine with CANBUS.
53	Idle Pulse input(ECU)	It is used for EFI engine with CANBUS.
54	60Hz Active(ECU)	It is used for EFI engine with CANBUS. When it is active, frequency is 60Hz.
55	Reserved	



No.	Type	Description
56	Reserved	
57	Reserved	
58	Reserved	
59	Mains Supply Active	When the input port is active, controller's power harvesting port detects mains voltage, and controller controls lighting tower follows the logic of mains supply.



NOTE: The user-defined names of input port 1~5 can be set only via PC software.

7.10 DEFINITION OF PROGRAMMABLE INPUT PORT 1-5

Table 28 – Definition of Input Ports

No.	Type	Range	Default	Function Description
1	Active Type	0~1	0	0 Close to Activate 1 Open to Activate
2	Working Range	0~3	2	0 Never: input port is deactivated. 1 Always: input always been detected. 2 From Crank: detection of input port starts from crank. 3 From Safety On: detection of input port starts from safety on delay expired. .
3	Action	0~3	1	0 Indication: only display status without warning and shutdown. 1 Warning: only warning without shutdown. 2 Shutdown: alarm and shutdown. 3 Trip and Stop: alarm→generator ramp-off load→stop after cooling.
4	Delay	(0~20.0)s	2.0	
5	User-defined Name	Users can define input port name	Chinese: 输入口 1~5; English: Input 1~5	PC software can write 10 Chinese characters and 20 English characters.



7.11 ENABLE DEFINITION OF PROGRAMMABLE OUTPUT PORT

Table 29 - Definition of Output Ports

No.	Type	Description
0	Not Used	
1	Air Flap Relay	Action when over speed shutdown and emergence stop. It also can close the air inflow to stop the engine as soon as possible.
2	Audible Alarm	Action when there are new warning/shutdown/trip and stop alarms occurred and the output delay can be set by users; it is can connect with external annunciator, when input "Alarm Mute" is active, this output is inhibit.
3	Battery High Voltage	Action when battery voltage is too high and controller initiates warning alarms. .
4	Battery Low Voltage	Action when battery voltage is too low and controller initiates warning alarms.
5	Low Oil Pressure Warning	Action when the input port that configured as "Low Oil Pressure Warning Input" is active and controller detects low oil pressure warning alarms.
6	Low Oil Pressure Shutdown	Action when the input port that configured as "Low Oil Pressure Shutdown Input" is active and controller detects low oil pressure shutdown alarms.
7	Oil Pressure Sensor Open Circuit Shutdown	Action when the input port that configured as "Oil Pressure Open Circuit Shutdown Input" is active and controller detects oil pressure sensor open circuit shutdown alarms.
8	Start Relay Output	Action when genset is cranking and disconnect when start successfully.
9	Fuel Relay Output	Action when genset is cranking and disconnect in waiting for stop delay.
10	Calling For Scheduled Run	In auto start mode, action when to start and disconnect when to stop.
11	Charge Alternator Fail	Action when charge failure warning alarms occurs or input port that configured as "External Charge Fail" is active.
12	Reserved	
13	Reserved	
14	Reserved	
15	Reserved	
16	Common Under Freq. Shutdown	Action when generator over/under frequency shutdown alarm occurs.
17	Common Under Freq. Warning	Action when generator over/under frequency warning alarm occurs.
18	Common Under Volt. Shutdown	Action when generator over/under voltage shutdown alarm occurs.
19	Common Under Volt. Warning	Action when generator over/under voltage warning alarm



No.	Type	Description
		occurs.
20	Common Alarm	Action when genset common warning, common shutdown, common trips alarm.
21	Common Trip and Stop Alarm	Action when common trips alarms occur.
22	Common Shutdown Alarm	Action when common shutdown alarms occur.
23	Common Warning Alarm	Action when common warning alarms occur.
24	High Temperature Warning	Action when the input port that configured as "High Temp Warning Input" is active and controller detects temperature high warning alarms.
25	High Temperature Shutdown	Action when the input port that configured as "High Temp Shutdown Input" is active and controller detects temperature high shutdown alarms.
26	Temp. Sensor Open Shutdown	Action when the input port that configured as "Temp. Open Circuit Input" is active and controller detects temperature sensor open circuit shutdown alarms.
27	Reserved	
28	Digital Input 1 Active	Action when input port 1 is active.
29	Digital Input 2 Active	Action when input port 2 is active
30	Digital Input 3 Active	Action when input port 3 is active
31	Digital Input 4 Active	Action when input port 4 is active
32	Digital Input 5 Active	Action when input port 5 is active
33	Reserved	
34	Emergency Stop	Action when emergency stop alarm occurs.
35	Energize to Stop	Action during ETS delay.
36	Failed to Start	Action when failed start alarm occurs.
37	Fuel Pump Control	It is closed when fuel level (associated sensor data) falls below pre-set "Fuel Pump On" limit value; it is open when fuel level exceeds pre-set "Fuel Pump Off" limit value or surpasses the maximum output time of fuel pump.
38	Generator Available	Action in period of generator normal running to hi-speed cooling.
39	Gen. Over Frequency Warning	Action when generator over frequency warning occurs.
40	Gen. Over Frequency Shutdown	Action when generator over frequency shutdown alarm occurs.
41	Gen. Over Volt Warning	Active when the voltage exceeds the <i>Over Voltage Warning</i> setting
42	Gen. Over Volt Shutdown	Active when the voltage exceeds the <i>Over Voltage Shutdown</i> setting
43	Gen. Under Freq. Warning	Active when the frequency falls below the <i>Under Frequency Warning</i> setting
44	Gen. Under Freq. Shutdown	Active when the frequency falls below the <i>Under Frequency Shutdown</i> setting



No.	Type	Description
45	Gen. Under Volt. Warning	Active when the voltage falls below the <i>Under Voltage Warning</i> setting
46	Gen. Under Volt. Shutdown	Active when the voltage falls below the <i>Under Voltage Shutdown</i> setting
47	Louver Control	Action when genset cranking and disconnect when genset stopped completely.
48	Low Fuel Level Warning	Action when the input port set as “Low Fuel Level Warning Input” is active and controller detects low fuel level warning alarm; or it is action when the input port set as “Low Fuel Level Shutdown Input” is active and controller detects low fuel level shutdown alarm.
49	Loss of Speed Signal	Action when detected engine speed value is 0 during normal running period.
50	ECU Stop	It is suit for EFI engine with ECU to control ECU stop.
51	ECU Power	It is suit for EFI engine with ECU to control ECU power supply.
52	ECU Warning	It is indicate that ECU has sent a warning alarm signal.
53	ECU Shutdown	It is indicate that ECU has sent a shutdown alarm signal.
54	ECU Communication Fail Shut	It is indicate that ECU has failed to communicate with controller.
55	ECU High Coolant Temp. Warning	It is output when the coolant temperature of ECU is high and arrived at the warning limit.
56	ECU High Coolant Temp. Shutdown	It is output when the coolant temperature of ECU is high and arrived at the shutdown limit.
57	ECU Low Oil Pressure Warning	It is output when the oil pressure of ECU is low and arrived at the warning limit.
58	ECU Low Oil Pressure Shutdown	It is output when the oil pressure of ECU is low and arrived at the shutdown limit.
59	Reserved	
60	Reserved	
61	Over Current Warning	Active when the current exceeds the <i>Over Current Warning</i> setting
62	Over Current Shutdown	Active when the current exceeds the <i>Over Current Shutdown</i> setting
63	Over Current Trip and Stop	Active when the current exceeds the <i>Over Current Trip and Stop</i> setting
64	Over Speed Warning	Active when the engine speed exceeds the <i>Over Speed Warning</i> setting
65	Over Speed Shutdown	Active when the engine speed exceeds the <i>Over Speed Shutdown</i> setting
66	Preheat (during pre-heat timer)	Action in period of preheat delay to cranking.
67	Preheat (until end of crank)	Action in period of preheat delay to the end of cranking delay.
68	Preheat (until end of WARM timer)	Action in period of preheat delay to the end of warming up delay.



No.	Type	Description
69	Preheat (until end of safety on)	Action in period of preheat delay to the end of safety on delay.
70	Cooling Timer In Process	Action in period of cooling delay.
71	Reserved	
72	System In Auto Mode	Action when system is in Auto mode.
73	System In Manual Mode	Action when system is in Manual mode.
74	System In Stop Mode	Action when system is in stop mode.
75	Under Speed Warning	Active when the engine speed falls below the <i>Under Speed Warning</i> setting
76	Under Speed Shutdown	Active when the engine speed falls below the <i>Under Speed Shutdown</i> setting
77	Reserved	
78	Idle Control	Action during “cranking---start idle” period and “stop idle --- waiting for stop” period.
79	Oil Pre-supply	Actions in period of cranking to safety on.
80	Raise Speed Energized	Action in warming up delay.
81	Excite Generator	Output in start period. If there is no generator frequency during hi-speed running, output for 2 seconds.
82	Drop Speed Energized	Action between the periods from “stop idle” to “wait for stop”.
83	Pre-Lubrication Output	Action in period of pre-heat to safety on.
84	Reserved	
85	Strobe Light	It is output between the periods from genset normal running to stop cooling, or output when genset fail to stop.
86	Audible Warning	Action when there are 10s left from start time in auto start mode and stop output after starting the generator.
87	Remote PC Output	Control genset via PC software or remote communication.
88	Reserved	Control the power supply of GSM modem.
89	Sensor 1 Open Circuit Warning	Active when the generator is warning due to sensor 1 is open circuit
90	Sensor 1 High Warning	Active when the generator is warning due to sensor 1 is too high.
91	Sensor 1 Low Warning	Active when the generator is warning due to sensor 1 is too low.
92	Sensor 1 High Shutdown	Active when the generator is shutdown due to sensor 1 is too high.
93	Sensor 1 Low Shutdown	Active when the generator is shutdown due to sensor 1 is too low.
94	Sensor 2 Open Circuit Warning	Active when the generator is warning due to sensor 2 is open circuit
95	Sensor 2 High Warning	Active when the generator is warning due to sensor 2 is too high.
96	Sensor 2 Low Warning	Active when the generator is warning due to sensor 2 is too low.
97	Sensor 2 High Shutdown	Active when the generator is shutdown due to sensor 2 is too high.



No.	Type	Description
98	Sensor 2 Low Shutdown	Active when the generator is shutdown due to sensor 2 is too low.
99	Sensor 3 Open Circuit Warning	Active when the generator is warning due to sensor 3 is open circuit
100	Sensor 3 High Warning	Active when the generator is warning due to sensor 3 is too high.
101	Sensor 3 Low Warning	Active when the generator is warning due to sensor 3 is too low.
102	Sensor 3 High Shutdown	Active when the generator is shutdown due to sensor 3 is too high.
103	Sensor 3 Low Shutdown	Active when the generator is shutdown due to sensor 3 is too low.
104	Rise Speed Pulse	Action time while entering into warming up period (rise speed pulse output time of timer settings). It is use to control partial ECU rise to normal speed. Default action time is 0.1s, and users can define it according to the requirement.
105	Drop Speed Pulse	Action time while entering into stop idle period (drop speed pulse output time of timer settings). It is use to control partial ECU rise to idle speed. Default action time is 0.1s, and users can define it according to the requirement.
106	1# Light Output	It is 1# light output action.
107	2# Light Output	It is 2# light output action.
108	3# Light Output	It is 3# light output action.
109	4# Light Output	It is 4# light output action.
110	Sensor 1 Open Circuit Shutdown	Active when the generator is shutdown due to sensor 1 open circuit.
111	Sensor 2 Open Circuit Shutdown	Active when the generator is shutdown due to sensor 2 open circuit.
112	Sensor 3 Open Circuit Shutdown	Active when the generator is shutdown due to sensor 3 open circuit.
113	Reserved	
114	Mains Normal	Action when mains are normal.
115	Mains Abnormal	Action when mains are abnormal.
116	Mains Over Frequency	Action when mains are over frequency.
117	Mains Under Frequency	Action when mains are under frequency.
118	Mains Over Voltage	Action when mains are over voltage.
119	Mains Under Voltage	Action when mains are under voltage.

7.12 OVER CURRENT ACTION

The formula of over current delay value:

$$T = t / ((I_A/I_T)-1)^2$$

T: Overcurrent delay (second)



- t: Timing multiplier ratio
- IA: Current max. load current (L1/L2/L3)
- IT: Overcurrent setting value

Example:

- t = 36
- IA = 600A
- IT = 500A

Conclusion: T = 900s(15 minutes)

7.13 LIGHT INPUT CONTROL MODE

ALC404 controller can define light input port as 3 modes: Feedback input, Control input and major control input.

After genset entering into normal running stage and for the light that configured as feedback input mode, controller automatically controls the output of the light according to the control logic, and the indicator on the panel shows the light on/off based on the light input port status.

In manual mode, after genset entering into normal running stage and for the light that configured as control input, controller controls the output of the light according to the light input port status, and the indicator on the panel shows the light on/off based on the light input port status; In auto mode, after genset entering into normal running stage, controller automatic controls the light output in turn after the delay, and the indicator on the panel shows the light on/off based on the light output port status.

If the light configured as major control input, at anytime (irrelevant to genset running status), the light output open/close only judged by the light input port status, and the indicator on the panel shows the light on/off based on the light input port status. Under this mode, controller cannot automatic control the light on/off.

▲ NOTE 1: If the light doesn't select any of 3 control modes, controller will control the light based on the *Feedback Input mode*, and the indicator on the panel shows the light on/off according to the light output port status.

▲ NOTE 2: Recommend users set all lights as the same control mode, aiming to make post-maintenance easier.

7.14 BATTERY LOW VOLT AGE START MODE (INVALID WHILE MAINS SUPPLY POWER)

After this function is active, starting battery under voltage start the genset to charge the battery, when pre-set voltage has been reached, genset stop automatically after the delay expired.

This feature is designed to protect the battery has enough power to start the unit. When the battery voltage has fallen below the set value, the unit cranks for a while and charge the battery; after running for a while, the unit will stop automatically after the battery voltage arrives at the pre-set unit stop limit. If starting



battery damaged and cannot be full charged, controller will force the unit to stop after the pre-set maximum *Under Voltage Charging Time* to prevent accidents.

The work mode can be set as Invalid, Auto Mode Active, Manual Mode Active, Auto And Manual Mode Active.

7.15 TIMER MODE SELECT

Timer start mode can be set as daily, weekly, monthly and custom daily start time in one week. Users can set the start time, run duration, detailed one day to start for each month / week, or custom weekday start or not start functions. If the run duration is set as 00:00, then the unit will not be started.

7.16 SUNRISE/SUNSET SETTING

Users can select corresponding city or define city's information (longitude, latitude and time zone) via PC software **Sunrise/set settings** and click **Sunrise/set Massage** to download the information into controller; then controller will run in auto sunrise/sunset mode.

▲ NOTE: The information can be configured by software via PC only.

7.17 LOW FUEL LEVEL REDUCE LIGHT NUMBER (INVALID WHILE MAINS SUPPLY POWER)

Choose **Low Fuel Level Light-off** settings of **Load Settings** page to reduce the number of lights along with the lowering of fuel level to reduce fuel consumption. If this function is enabled and fuel level associated with the sensor, lights number can be reduced automatically through adjusting parameters of **Low Fuel Level Light-off** settings.

7.18 REALIZE MAINS SUPPLY POWER VIA EXTERNAL DIGITAL INPUT PORT

This function allows external connected mains to supply power for the unit. If mains are active, whatever working mode the unit states, genset will stop (genset not in standby status) and not allowed to start. At the moment, mains active/reactive/apparent power and power factor are calculated by the controller (total energy/start time, and current energy/start time are not calculate), meanwhile, controller overall controls the light based on the mains status.

Controller uses the same port as the generator sampling voltage to sampling mains voltage. If use this function, mains/generator switch function must be controller external of the controller. When the input port that configured as **59 Mains Supply Active** is active, controller will judge the detecting voltage is mains supply.

When mains supply is active, engine shuts down, but the light controlled still keep the previous status.

When mains supply is active, controller can only control the lights on the lighthouse on and off, but not control the genset start up.

When mains supply is abnormal, controller enters into mains abnormal delay, and all lights are turned off after the delay. When mains supply is normal, all lights are turned on again.



7.19 DEEP SLEEP MODE

7.19.1 CONDITIONS OF ENTERING INTO DEEP SLEEP MODE

Conditions of entering into low power consumption mode are as follows,

Condition 1: Generator states in standby status, all lights are turned off and no buttons are pressed before deep sleep delay expired.

Condition 2: Digital input port 1 configured as **04 Remote Start**, and auto remote start signal is deactivated.

Condition 3: There are no auto start signals in 3 minutes.

Controller enters into low power consumption mode automatically if meet conditions as follows: (1) satisfy condition 1 in manual mode; (2) satisfy condition 1 and condition 2 simultaneously in remote start mode; (3) satisfy condition 1, condition 2 and condition 3 simultaneously in both timer start mode and sunrise/set start mode.

7.19.2 EXIT DEEP SLEEP MODE METHOD

Methods of exiting deep sleep mode are as follows,

Method 1: Press  or  button of controller to exit low power consumption mode.

Method 2: Realizing remote start to wake controller from deep sleep mode must configure input port 1 as **04 Remote Start Input**, firstly, activate input port 1 and then deactivate it to exit low power consumption.

Method 3: In the mode of timer start mode or sunrise/set, system will wake controller from deep sleep mode. Wake time is pre-set auto start time plus 3s.

Controller exit low power consumption mode by the following ways: (1) satisfy method 1 in manual mode; (2) satisfy method 1 or method 2 in remote start mode; (3) satisfy method 1 or method 2 or method 3 in both timer start mode and sunrise/set start mode.

▲ NOTE: If awake from deep sleep mode, controller will re-read "Power on mode", thus, recommend users to set controller "Power on mode" before controller enters into deep sleep mode.



8 PARAMETERS SETTING

8.1 SETTING MENU DESCRIPTION

Start the controller, then press  to enter into the parameters setting menu, menu items are as follows:

- Return
- Set Parameters
- Time Calibration
- Language Select
- Event Log
- Information

Users can jump to parameter setting, time calibration, language selection, event log, information query and other screens.

8.2 PARAMETERS SETTING



When entered password interface, inputting “00318” can set all parameter items in table 7.1 *AUTO START PARAMETER SETTINGS* and table 7.2 *GENERIC PARAMETER SETTINGS*. If the password is changed only input the password same as controllers’, can the parameter be set via PC software. If there is need to set more parameters or password is forgotten, please contact the factory.

NOTES:

- a) Please change the controller parameters when generator is in standby mode (e. g. Crank disconnect conditions selection, digital inputs, relay outputs, various delays), otherwise, shutdown and other abnormal conditions may occurs.
- b) Over voltage set value must be higher than under voltage set value, otherwise over voltage and under voltage condition may occur simultaneously.
- c) Over speed set value must be higher than under speed set value, otherwise over speed and under speed condition may occur simultaneously.
- d) Please set the generator frequency value as low as possible when cranking, in order to make the starter be separated quickly as soon as possible.
- e) Auxiliary input 1~7 cannot set as same items; otherwise, there are abnormal functions. However, the auxiliary output 1~6 can be set as same items.
- f) Flexible sensor 1~3 can be configured as temperature sensor, pressure sensor or fuel level sensor. Simultaneously, sensors must connect to related coolant temperature, oil pressure and fuel level display on the mains screen (when EFI engine set is controlled, only fuel level display is connected).

8.3 CONTROLLER TIME CALIBRATION

Table 30 – Time Calibration Process

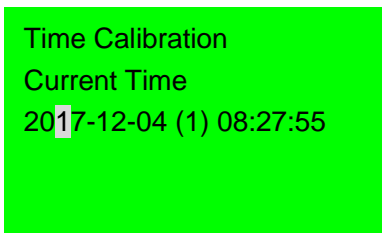
No.	Operation Process	Panel Display
1	After controller power on, press  , then select Time Calibration , press  again to the Date and Time Setting interface. The date and time displayed will be stopped and digital that highlight with black is currently adaptable for user	



No.	Operation Process	Panel Display
	by pressing key and key to increase and decrease the value. Press key to confirm setting and the bit will right move automatically. Number “1” in the parenthesis is the week information. It is set by the microprocessor based on current date, so the user does not need to modify it.	

NOTE: Press at any time during setting process can interrupt current setting and return to the main menu.

8.4 LANGUAGE SELECTION

In this screen, Chinese and English can be optional.

8.5 EVENT LOG

Maximum 99 pieces of event logs (time of start/stop and fault shutdown events) can be circularly stored into ALC404 controller, and fault shutdown events include fault shutdown type and occurs time and date. If the alarm records are more than 99 pieces, then the latest record will replace the oldest one. Event log display please to see the following table,

Table 31 – Event Logs

No.	Operation Process	Panel Display
1	Press in main screen, and then select Event Log , press again to inquiry the event log (See right picture). Press and to read records and or to exit directly.	



8.6 CONTROLLER INFORMATION

Controller information page displays release information (software/hardware version and issue date), boot screen and input/output ports status.

9 COMMISSIONING

Please make the under procedures checking before commissioning,

- Ensure all the connections are correct and wires diameter is suitable.
- Ensure that the controller DC power has fuse, controller's positive and negative connected to start battery are correct.
- Take proper action to prevent engine to crank disconnect (e. g. Remove the connection wire of fuel valve). If checking is OK, make the start battery power on; choose manual mode and controller will executive routine.
- Set controller under manual mode, press "start" button, genset will start. After the cranking times as setting, controller will send signal of *Start Fail*; then press "stop" to reset controller.
- Recover the action of prevent engine start (e. g. Connect wire of fuel valve), press start button again, genset will start. If everything goes well, genset will normal run after idle running (if idle run be set). During this time, please watch for engine's running situations and AC generator's voltage and frequency. If abnormal, stop genset running and check all wires connection according to this manual.

Any other questions please contact technical personnel of factory in time.



10 CONNECTIONS OF CONTROLLER WITH J1939 ENGINE

10.1 CUMMINS ISB/ISBE

Table 32 - Connector B

Terminals of controller	Connector B	Remark
Aux. output 1	39	Aux. output 1 configured as "Fuel Output"
Start relay output	-	Connect with starter coil directly.
Auxiliary output 2	Expand 30A relay, battery voltage of 01,07,12,13 is supplied by relay.	ECU power Set Auxiliary output 2 as "ECU power".

Table 33 - 9Pins Connector

Terminals of controller	9 pins connector	Remark
	SAE J1939 shield	CAN communication shielding line (connect with ECU terminal only).
CAN(H)	SAE J1939 signal	
CAN(L)	SAE J1939 return	

Engine type: Cummins ISB

10.2 CUMMINS QSL9

Suitable for CM850 engine control mode

Table 34 - 50Pins Connector

Terminals of controller	50 pins connector	Remark
Aux. output 1	39	Aux. output 1 configured as "Fuel Output"
Starter relay output	-	Connect to 34 starter coil directly.

Table 35 - 9Pins Connector

Terminals of controller	9 pins connector	Remark
	SAE J1939 shield-E	CAN communication shielding line (connect with ECU terminal only).
CAN(H)	SAE J1939 signal-C	
CAN(L)	SAE J1939 return-D	

Engine type: Cummins-CM850



10.3 CUMMINS QSM11 (IMPORT)

It is suitable for CM570 engine control module. Engine type is QSM11 G1, QSM11 G2.

Table 36 - C1Pin Connector

Terminals of controller	C1 connector	Remark
Aux. output 1	5&8	Aux. output 1 configured as "Fuel Output". Outside expand relay, when fuel output, making port 5 and port 8 of C1 be connected.
Start relay output	-	Connect to starter coil directly.

Table 37 - 3Pins Data Link Connector

Terminals of controller	3 pins data link connector	Remark
	C	CAN communication shielding line (connect with ECU terminal only).
CAN(H)	A	
CAN(L)	B	

Engine type: Cummins ISB

10.4 CUMMINS QSX15-CM570

It is suitable for CM570 engine control module. Engine type is QSX15.

Table 38 - 50Pins Connector

Terminals of controller	50 pins connector	Remark
Aux. output 1	38	Oil spout switch; Aux. output 1 configured as "Fuel Output".
Starter relay output	-	Connect to starter coil directly.

Table 39 - 9Pins Connector

Terminals of controller	9 pins connector	Remark
	SAE J1939 shield-E	CAN communication shielding line (Connect with ECU terminal only).
CAN(H)	SAE J1939 signal-C	
CAN(L)	SAE J1939 return-D	

Engine type: Cummins QSX15-CM570

10.5 CUMMINS QSM11

Table 40 - Engine OEM Connector

Terminals of controller	OEM connector of engine	Remark
Aux. output 1	38	Aux. output 1 configured as "Fuel Output".
Starter relay output	-	Connect with starter coil directly.
	-	CAN communication shielding line.
CAN(H)	46	
CAN(L)	37	



Engine type: common J1939

10.6 CUMMINS QSZ13

Table 41 - Engine OEM Connector

Terminals of controller	OEM connector of engine	Remark
Aux. output 1	45	Aux. output 1 configured as "Fuel Output"
Starter relay output	-	Connect to starter coil directly
Aux. output 2	16&41	Setting to idle speed control, normally open output. Making 16 connect to 41 during high-speed running of controller via external expansion relay.
Aux. output 3	19&41	Setting to pulse raise speed control, normally open output. Making 19 connect with 41 for 0.1s during high-speed warming of controller via external expansion relay.
CAN GND	-	CAN communication shielding line.
CAN(H)	1	
CAN(L)	21	

Engine type: Common J1939

10.7 DETROIT DIESEL DDEC III / IV

Table 42 - Engine CAN Connector

Terminals of controller	CAN port of engine	Remark
Aux. output 1	Expand 30A relay, battery voltage of ECU is supplied by relay.	Aux. output 1 configured as "Fuel Output".
Start relay output	-	Connect to starter coil directly.
	-	CAN communication shielding line.
CAN(H)	CAN(H)	
CAN(L)	CAN(L)	

Engine type: Common J1939

10.8 DEUTZ EMR2

Table 43 - F Connector

Terminals of controller	F connector	Remark
Aux. output 1	Expand 30A relay, battery voltage of 14 is supplied by relay. Fuse is 16A.	Aux. output 1 configured as "Fuel Output".
Starter relay output	-	Connect to starter coil directly.
-	1	Connect to battery negative pole.
	-	CAN communication shielding line.
CAN(H)	12	



CAN(L)	13	
--------	----	--

Engine type: VolvoEDC4

10.9 JOHN DEERE

Table 44 - 21Pins Connector

Terminals of controller	21 pins connector	Remark
Aux. output 1	G, J	Aux. output 1 configured as "Fuel Output".
Starter relay output	D	
	-	CAN communication shielding line.
CAN(H)	V	
CAN(L)	U	

Engine type: John Deere

10.10 MTU MDEC

Suitable for MTU engines, 2000 series, 4000series

Table 45 - X1 Pin Connector

Terminals of controller	X1 connector	Remark
Aux. output 1	BE1	Aux. output 1 configured as "Fuel Output".
Start relay output	BE9	
	E	CAN communication shielding line (connect with one terminal only).
CAN(H)	G	
CAN(L)	F	

Engine type: MTU-MDEC-303

10.11 MTU ADEC(SMART MODULE)

It is suitable for MTU engine with ADEC (ECU8) and SMART module.

Table 46 - ADEC(X1 Connector)

Terminals of controller	ADEC (X1port)	Remark
Aux. output 1	X1 10	Aux. output 1 configured as "Fuel Output". X1 Terminal 9 Connected to negative of battery
Start relay output	X1 34	X1 Terminal 33 Connected to negative of battery

Table 47 - ADEC(X4 Connector)

Terminals of controller	SMART (X4 port)	Remark
	X4 3	CAN communication shielding line.
CAN(H)	X4 1	
CAN(L)	X4 2	

Engine type: MTU-ADEC



10.12 MTU ADEC (SAM MODULE)

It is suitable for MTU engine with ADEC (ECU7) and SAM module.

Table 48 - ADEC(X1 Connector)

Terminals of controller	ADEC (X1port)	Remark
Aux. output 1	X1 43	Aux. output 1 configured as "Fuel Output". X1 Terminal 28 Connected to negative of battery.
Starter relay output	X1 37	X1 Terminal 22 Connected to negative of battery.

Table 49 - SAM(X23 Connector)

Terminals of controller	SAM (X23 port)	Remark
	X23 3	CAN communication shielding line.
CAN(H)	X23 2	
CAN(L)	X23 1	

Engine type: Common J1939

10.13 PERKINS

It is suitable for ADEM3/ ADEM4 engine control module. Engine type is 2306, 2506, 1106, and 2806.

Table 50 - Connector

Terminals of controller	Connector	Remark
Aux. output 1	1,10,15,33,34	Aux. output 1 configured as "Fuel Output".
Starter relay output	-	Connect to starter coil directly.
	-	CAN communication shielding line.
CAN(H)	31	
CAN(L)	32	

Engine type: Perkins

10.14 SCANIA

It is suitable for S6 engine control module. Engine type is DC9, DC12, and DC16.

Table 51 - B1 Connector

Terminals of controller	B1 connector	Remark
Aux. output 1	3	Aux. output 1 configured as "Fuel Output".
Starter relay output	-	Connect to starter coil directly.
	-	CAN communication shielding line.
CAN(H)	9	
CAN(L)	10	

Engine type: Scania



10.15 VOLVO EDC3

Suitable engine control mode is TAD1240, TAD1241, and TAD1242.

Table 52 - "Stand alone" Connector

Terminals of controller	"Stand alone" connector	Remark
Aux. output 1	H	Aux. output 1 configured as "Fuel Output".
Start relay output	E	
Auxiliary Output 2	P	ECU power Configurable output 2,"ECU power" .

Table 52 - "Data bus" Connector

Terminals of controller	"Data bus" connector	Remark
	-	CAN communication shielding line.
CAN(H)	1	
CAN(L)	2	

Engine type: Volvo

▲NOTE: When this engine type is selected, preheating time should be set to at least 3 seconds.

10.16 VOLVO EDC4

Suitable engine types: TD520, TAD520 (optional), TD720, TAD720 (optional), TAD721, TAD722, and TAD732.

Table 54 - Connector

Terminals of controller	Connector	Remark
Aux. output 1	Expanded 30A relay, and relay offers battery voltage for terminal14. Fuse is 16A	Aux. output 1 configured as "Fuel Output".
Start relay output	-	Connect to starter coil directly.
	1	Connected to negative of battery.
	-	CAN communication shielding line.
CAN(H)	12	
CAN(L)	13	

Engine type: VolvoEDC4

10.17 VOLVO-EMS2

Volvo Engine types are TAD734, TAD940, TAD941, TAD1640, TAD1641, and TAD1642.

Table 55 - Engine CAN Connector

Terminals of controller	Engine's CAN port	Remark
Auxiliary output 1	6	ECU stop Configurable output 1 "ECU stop".
Auxiliary output 2	5	ECU power Configurable output 2 "ECU power".
	3	Negative power
	4	Positive power



Terminals of controller	Engine's CAN port	Remark
	-	CAN communication shielding line.
CAN(H)	1(Hi)	
CAN(L)	2(Lo)	

Engine type: Volvo-EMS2

▲NOTE: When this engine type is selected, preheating time should be set to at least 3 seconds.

10.18 YUCHAI

It is suitable for BOSCH common rail pump engine.

Table 56 - Engine 42 Pin Connector

Terminals of controller	Engine 42 pins port	Remark
Aux. output 1	1.40	Aux. output 1 configured as "Fuel Output". Connect to engine ignition lock.
Starter relay output	-	Connect to starter coil directly.
	-	CAN communication shielding line.
CAN(H)	1.35	
CAN(L)	1.34	

Table 57 - Engine 2 Pin Connector

Battery	Engine 2 pins	Remark
Battery negative	1	Wire diameter 2.5mm ²
Battery positive	2	Wire diameter 2.5mm ²

Engine type: BOSCH

10.19 WEICHAI

It is suitable for Weichai BOSCH common rail pump engine.

Table 58 - Engine Connector

Terminals of controller	Engine port	Remark
Aux. output 1	1.40	Aux. output 1 configured as "Fuel Output". Connect to engine ignition lock.
Starter relay output	1.61	
	-	CAN communication shielding line.
CAN(H)	1.35	
CAN(L)	1.34	

Engine type: GTSC1

▲NOTE: CAN(H) and CAN(L) of ALC404 controller has integrated with 120Ω matched resistance, therefore, there is no need additional matched resistor while making CAN communication wire.

▲NOTE: If there is any question of connection between controller and ECU communication, please feel free to contact SmartGen's service.



11 TYPICAL WIRING DIAGRAMS

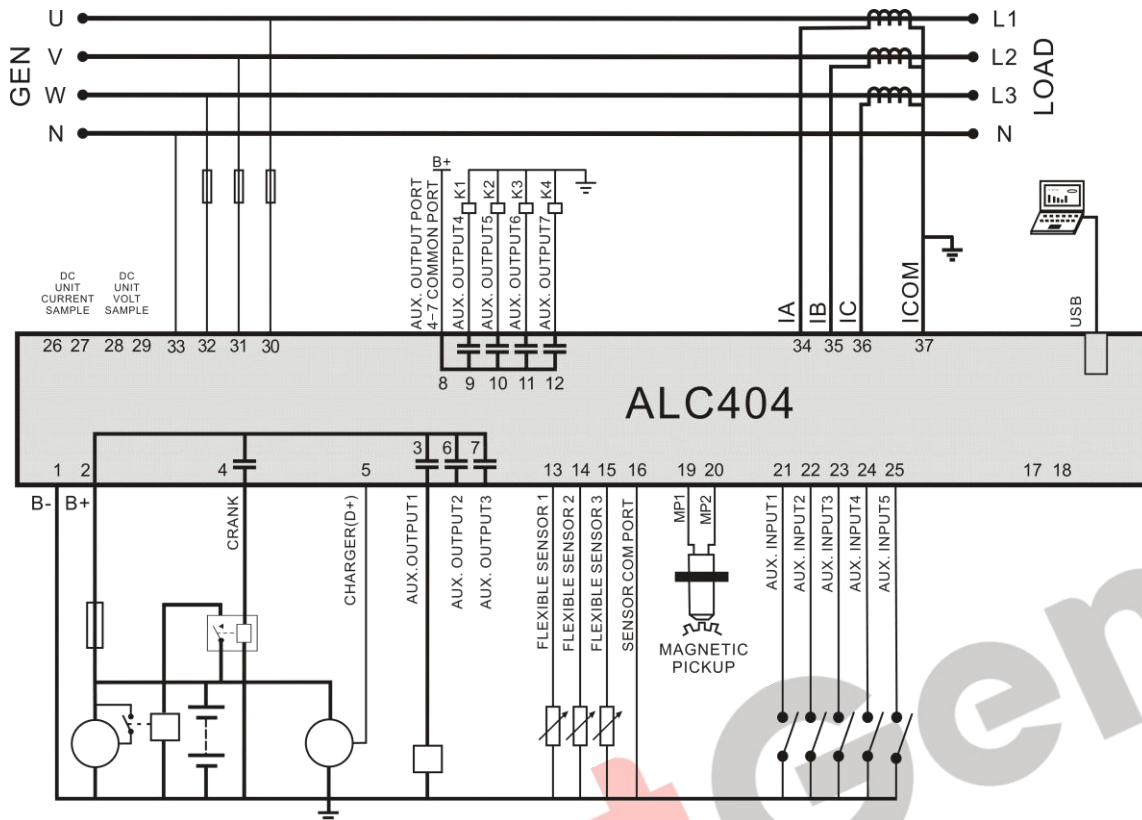

Fig. 4 – ALC404 Controls AC Non-EFI Engine Set Application (3P4W)

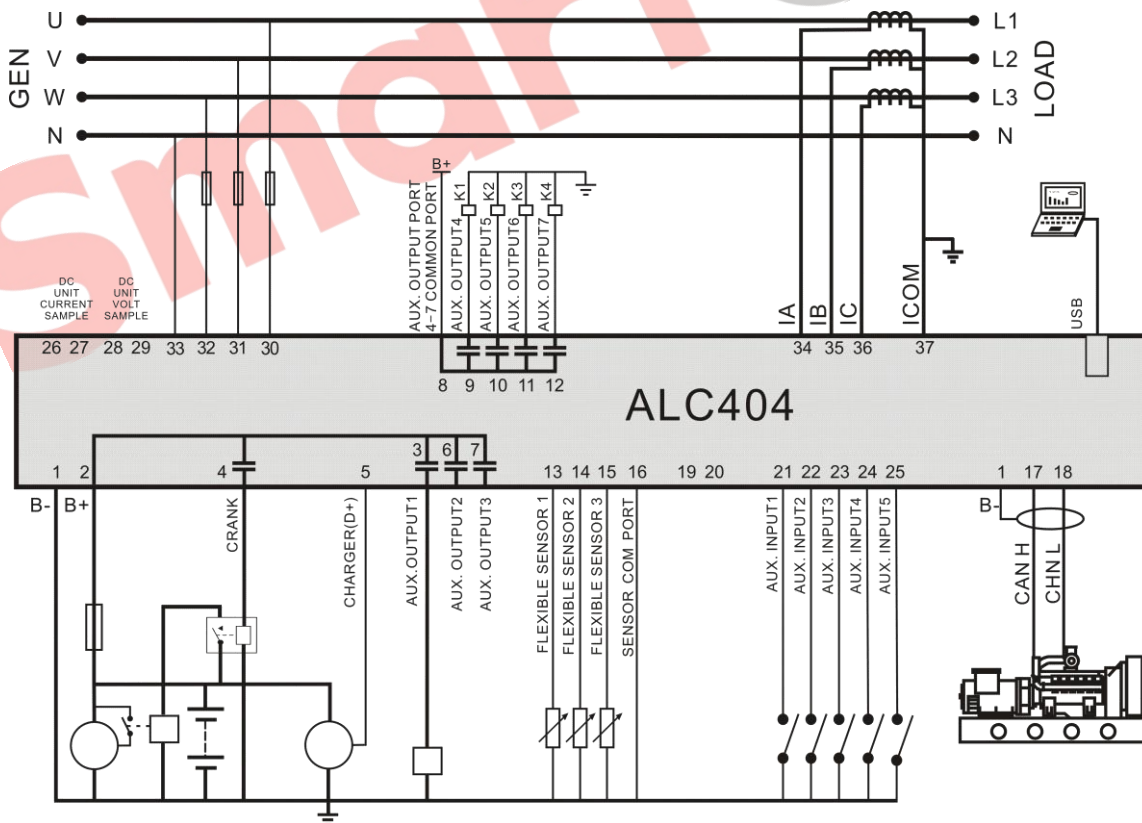

Fig. 5 – ALC404 Controls AC EFI Engine Set Application (3P4W)

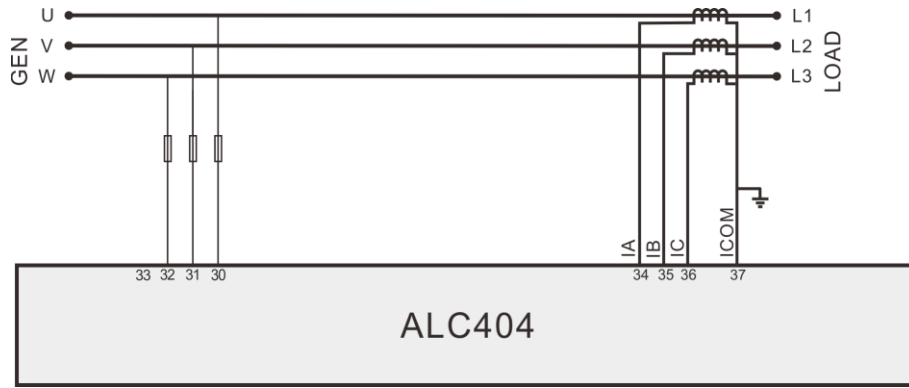

Fig. 6 – ALC404 Controls AC Unit Application (3P3W)

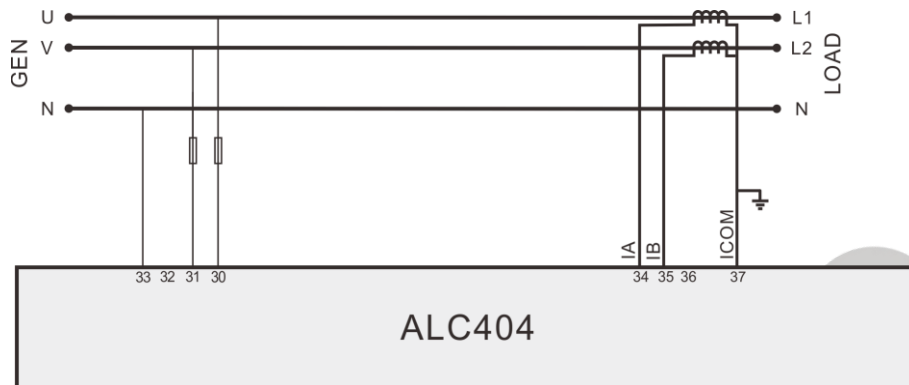

Fig. 7 – ALC404 Controls AC Unit Application (2P3W)

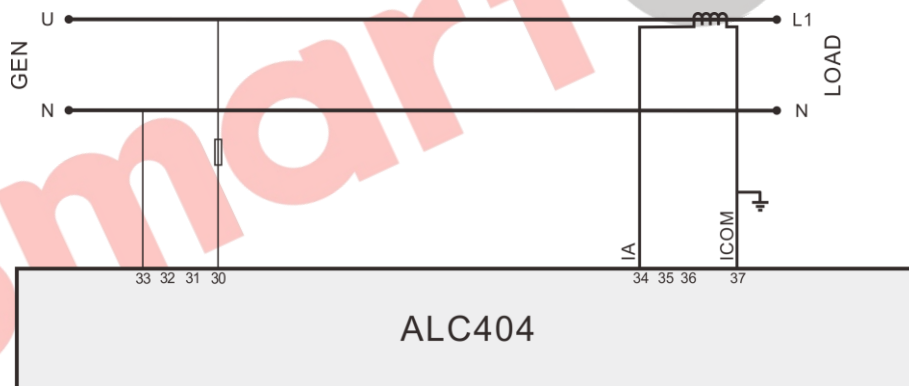

Fig.8 – ALC404 Controls AC Unit Application (1P2W)

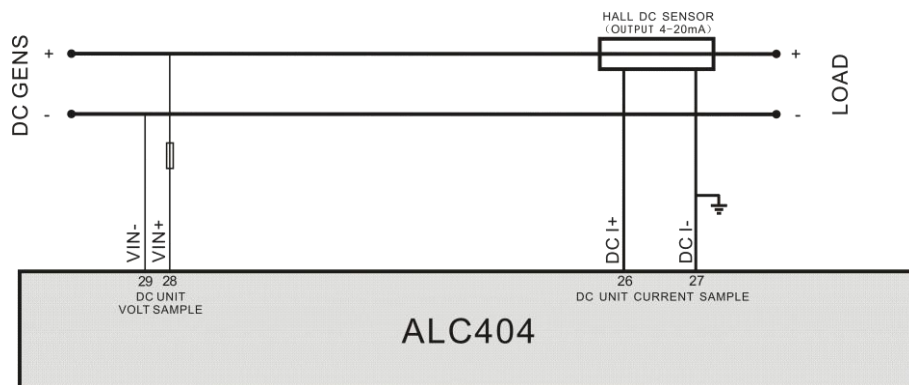

Fig. 9 – ALC404 Controls DC Unit Application



▲ NOTE 1: If external lamps needed to be connected, users can configure the relay output port 4~7 as 1#~4# lamp output, simultaneously, select the corresponding external expand capacity relay based on the load power.

▲ NOTE 2: Non-EFI engine set can configure the flexible sensor 1-3 separately as engine temperature, oil pressure and fuel level to realize the routine controlling of the genset.

▲ NOTE 3: EFI engine set can configure flexible sensor 1 as fuel level, and the other two sensors are freely set to realize the routine controlling of the genset.

▲ NOTE 4: While controlling of the DC genset, users need to select the appropriate DC Hall sensors based on the output power and current of the lighting tower unit.

▲ NOTE 5: While controlling of the DC genset, related generator over/under frequency alarms are inactive.

SmartGen



12 INSTALLATION

12.1 FIXING CLIPS

- Controller is panel built-in design; it is fixed by clips when installed.
- Withdraw the fixing clip screw (turn anticlockwise) until it reaches proper position.
- Pull the fixing clip backwards (towards the back of the module) ensuring two clips are inside their allotted slots.
- Turn the fixing clip screws clockwise until they are fixed on the panel.

▲ **Note:** Care should be taken not to over tighten the screws of fixing clips.

12.2 OVERALL AND CUTOUT DIMENSIONS

ALC404 controller is panel built-in design, and fixed by clips when installed. Overall dimension and cutout dimension are as follows,

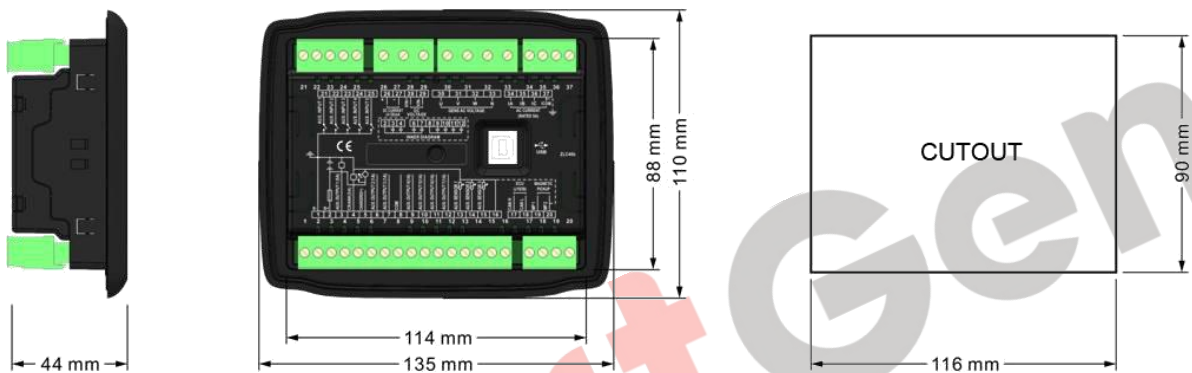

Figure 9 - Overall Dimensions

12.3 WIRING CONNECTION DESCRIPTION

Battery Voltage Input: ALC404 controller can suit for widely range of battery voltage DC (8~35) V. Negative of battery must be connected with the engine shell. Diameter of wire that connects from power supply to battery must be over 1.5mm². If floating charge configured, please firstly connect output wires of charger to battery's positive and negative directly, then, connect wires from battery's positive and negative to controller's positive and negative input ports in order to prevent charge disturbing the controller's normal working.

Speed Sensor Input: Speed sensor is the magnetic equipment which be installed in starter and for detecting flywheel teeth. Its connection wires to controller should apply for 2 cores shielding line. The shielding layer should connect to No. 20 terminal in controller and the else two signal wires are connected to No.19 and No.20 terminals in controller. The output voltage of speed sensor should be within (1~24) VAC (effective value) during the full speed. 12VAC is recommended (in rated speed). When install the speed sensor, let the sensor is spun to contacting flywheel first, then, port out 1/3 lap, and lock the nuts of sensor at last.

Output and Expand Relays: All outputs of controller are relay contact output type. If need to expand the relays, please add freewheel diode to both ends of expand relay's coils (when coils of relay has DC current) or, increase resistance-capacitance return circuit (when coils of relay has AC current), in order to prevent disturbance to controller or others equipment.

AC Current Input: Current input of ALC404 controller must be connected to outside current transformer. And the current transformer's secondary side current must be 5A. At the same time, the phases of current



transformer and input voltage must correct. Otherwise, the current of collecting and active power maybe not correct.

▲NOTE:

- a) **ICOM port must be connected to negative pole of battery.**
- b) **When there is load current, transformer’s secondary side prohibit open circuit.**

DC Current Input: Current input of ALC404 controller must be external connected to DC Hall sensor with output current 4~20mA.

Withstand Voltage Test: When controller had been installed in control panel, if need the high voltage test, please disconnect controller’s all terminal connections, in order to prevent high voltage into controller and damage it.

13 TROUBLESHOOTING

Here are the common faults and troubleshooting. If there is any other problem, please feel free to contact SmartGen’s service.

Symptoms	Possible Solutions
Controller no response with power.	Check starting batteries; Check controller connection wirings; Check DC fuse.
Light tower set shutdown	Check whether the water/cylinder temperature is too high or not; Check the generator AC voltage; Check DC fuse.
Controller emergency stop	Check emergence stop button is correct or not; Check whether the starting battery positive be connected with the emergency stop input; Check whether the circuit is open circuit.
Low oil pressure alarm after crank disconnect	Check the oil pressure sensor and its connections.
High water/cylinder temp. alarm after crank disconnect	Check the temperature sensor and its connections.
Shutdown Alarm in running	Check related switch and its connections according to the information on LCD; Check programmable inputs.
Start Failure	Check fuel circuit and its connections; Check starting batteries; Check speed sensor and its connections; Refer to engine manual.
Starter no response	Check starter connections; Check starting batteries.