



**SmartGen**  
ideas for power

## HAT700 SERIES

HAT700/HAT700I/HAT700B/HAT700BI/HAT700S

## ATS CONTROLLER

## USER MANUAL



**SMARTGEN (ZHENGZHOU) TECHNOLOGY CO., LTD.**



Chinese trademark

**SmartGen** English trademark**SmartGen** — make your generator *smart***SmartGen Technology Co., Ltd.****No.28 Jinsuo Road****Zhengzhou****Henan Province****P. R. China****Tel:** 0086-371-67988888/67981888

0086-371-67991553/67992951

0086-371-67981000(overseas)

**Fax:** 0086-371-67992952**Web:** <http://www.smartgen.com.cn><http://www.smartgen.cn>**Email:** [sales@smartgen.cn](mailto:sales@smartgen.cn)

All rights reserved. No part of this publication may be reproduced in any material form (including photocopying or storing in any medium by electronic means or other) without the written permission of the copyright holder.

Applications for the copyright holder's written permission to reproduce any part of this publication should be addressed to Smartgen Technology at the address above.

Any reference to trademarked product names used within this publication is owned by their respective companies.

SmartGen Technology reserves the right to change the contents of this document without prior notice.

#### Software Version

Version	Date	Note
1.0	2014-09-09	Original release.
1.1	2015-03-04	HAT700s is added.
1.2	2015-04-30	Renew character strings.
1.3	2015-11-16	Change the name of VITZRO wiring diagram as VITZRO/PHETENG.
1.4	2016-11-07	S1, S2 Start type add "Not Used" option.



# CONTENT

1	OVERVIEW .....	5
2	ORDER INFORMATION AND MODULES COMPARISON .....	5
2.1	ORDER INFORMATION .....	5
2.2	MODULES COMPARISON .....	5
3	PERFORMANCE AND CHARACTERISTICS .....	6
4	SPECIFICATION .....	7
5	MEASURE AND DISPLAY DATA .....	8
6	OPERATION .....	9
6.1	INDICATORS .....	9
6.2	KEY FUNCTION DESCRIPTION .....	10
7	LCD DISPLAY .....	11
7.1	MAIN SCREEN .....	11
7.2	STATUS DESCRIPTION .....	13
7.2.1	S1 VOLTAGE STATUS .....	13
7.2.2	S2 VOLTAGE STATUS .....	13
7.2.3	GENSET STATUS .....	13
7.2.4	SWITCH STATUS .....	14
7.2.5	WARN ALARMS .....	14
7.2.6	FAULT ALARMS .....	15
7.2.7	INDICATION .....	15
7.2.8	OTHERS .....	16
7.3	MAIN MENU .....	16
8	START/STOP OPERATION .....	17
8.1	MANUAL START/STOP .....	17
8.1.1	PANEL START/STOP .....	17
8.1.2	REMOTE START/STOP .....	17
8.2	AUTO START/STOP .....	17
8.2.1	INPUT PORT START/STOP OPERATION .....	17
8.2.2	“S1 GENS S2 GENS” START/STOP .....	18
8.2.3	SCHEDULED RUN .....	19
8.2.4	SCHEDULED NOT RUN .....	19
9	PARAMETERS CONFIGURATION .....	20
9.1	ILLUSTRATION .....	20
9.2	PARAMETERS TABLE .....	20
9.3	INPUT/OUTPUT FUNCTION DESCRIPTION .....	28
9.3.1	INPUT PORTS FUNCTION .....	28
9.3.2	OUTPUT PORTS FUNCTION .....	29
9.3.3	CUSTOM PERIOD OUTPUT .....	32
9.4	DEFINITE TIME DELAY AND INVERSE DEFINITE MINIMUM TIME SETTING .....	33
10	EVENT LOG .....	34
11	ATS OPERATION .....	36
11.1	MANUAL OPERATION .....	36
11.2	AUTOMATIC OPERATION .....	36
11.3	SYNC CLOSING .....	36



12	ATS POWER SUPPLY.....	39
13	LOAD SHEDDING.....	40
14	COMMUNICATION CONFIGURATION.....	41
15	DESCRIPTION OF CONNECTING TERMINALS .....	41
16	TYPICAL WIRING DIAGRAM .....	43
17	INSTALLATION .....	51
18	FAULT FINDING .....	51

SmartGen

## 1 OVERVIEW

**HAT700** series ATS controller is intelligent dual-supply module with configurable function, automatic measurement, LCD display, and digital communication. It combines digital, intelligence and networking. Automatic measurement and control can reduce incorrect operation. It is an ideal option for ATS.

The powerful Microprocessor contained within the unit allows for precision voltage (2-way-3-phase) measuring and make accurate judgment; in addition, the corresponding digital output port will active when there is over/under voltage, over/under frequency, loss of phase and other abnormal condition occurs. This controller has full consideration in various application of ATS (automatic transfer system) and can be directly used for PC ATS, CB ATS, CC ATS etc. It has compact structure, advanced circuits, simple wiring and high reliability, and can be widely used in electrical devices, automatic control and testing system of electric power, telecommunications, petroleum, coal, metallurgy, railways, municipal administration, intelligent building, etc.

## 2 ORDER INFORMATION AND MODULES COMPARISON

### 2.1 ORDER INFORMATION

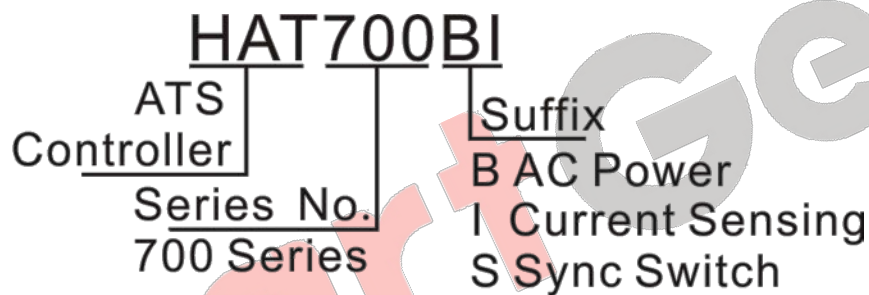

### 2.2 MODULES COMPARISON

Function							
Type	DC Power	AC Power Supply	AC Current & Power	Sync Close	Input Ports (Fixed+Config.)	Output Ports (Fixed+Config.)	RS485
HAT700	•				2+4	2+6	•
HAT700B	•	• (LN90V~280V)			2+4	2+6	•
HAT700I	•		•		2+4	2+6	•
HAT700BI	•	• (LN90V~280V)	•		2+4	2+6	•
HAT700S	•	• (LN90V~280V)	•	•	2+4	2+6	•

### 3 PERFORMANCE AND CHARACTERISTICS

- 1) System type can set as: S1 (Mains) & S2 (Mains), S1 (Mains) & S2 (Generator), S1 (Generator) & S2 (Mains), S1 (Generator) & S2 (Generator).
- 2) 132x64 LCD with backlight, multilingual interface (including English, Chinese or other languages), push-button operation.
- 3) Collect and display 2-way 3-phase Voltage, Frequency and Phase.
- 4) Collect and display Active Power, Reactive Power, Apparent Power, Power Factor and Current.
- 5) S1/S2 separated over current warning/ trip alarm.
- 6) NEL (Non-essential Load) trip function.
- 7) Display S1/S2 Total kW Energy, Total kvar Energy, Total Close Times.
- 8) Display continuous power supply time and S1/S2 total power supply time.
- 9) Sync Transfer function; in addition, Voltage Difference, Frequency Difference and Phase Difference can be displayed.
- 10) For Stored-Energy type ATS, its close relay will active after the PF Input is active.
- 11) Over/under voltage, loss of phase, reverse phase sequence, over/under frequency protection.
- 12) Phase Sequence Transfer function.
- 13) Automatic/Manual mode. In manual mode, can force the switch to close or open;
- 14) All parameters can be set on site. Passwords authentication ensures authorized staff operation only.
- 15) The genset can be Manual Test on site to achieve start/stop operation.
- 16) ATS Controller has function of automatic Re-closing.
- 17) Closing output signal can be set as on intervals or as continuous output.
- 18) Applicable for PC Three-stage, PC Two-stage, CB and CC switch.
- 19) Applicable for 2 isolated neutral line.
- 20) Real-time clock (RTC); Event log Function (Event log can record 99 items circularly).
- 21) Scheduled Run & Scheduled Not Run (can be set as start genset once a day/week/month whether with load or not).
- 22) Can control two generators to work as Cycle Run mode, Master Run mode and Balance Run mode.
- 23) Widely power supply range DC(8~35)V allows the controller can bear 80V instantaneous current.
- 24) Large terminal space allows the controller can bear maximum 625V input voltage.
- 25) With RS485 isolated communication interface. With "remote controlling, remote measuring, remote communication, remote regulating" function by the ModBus communication protocol. Can remote start/stop the genset and remote control the ATS to close or open.
- 26) Suitable for various AC systems (3 phase 4-wires, 3-phase 3-wires, single-phase 2-wire, and 2-phase 3-wire).
- 27) Modular design, self extinguishing ABS plastic shell, pluggable terminal, built-in mounting, compact structure with easy installation.

#### 4 SPECIFICATION

Items	Contents		
Operating Voltage	1. DC 8.0V~35.0V, continuous power supply. 2. AC90V~280V during AC power supply L1N1/L2N2 (HAT700B/HAT700BI/HAT700S).		
Power Consumption	<5W (Standby mode: ≤2W)		
AC Voltage Input	AC system	HAT700/HAT700I	HAT700B/HAT700BI/HAT700S
	3P4W (L-L)	(80~625)V	(80~480)V
	3P3W (L-L)	(80~625)V	(80~625)V
	1P2W (L-N)	(50~360)V	(50~280)V
	2P3W (A-B)	(80~625)V	(80~480)V
Rated Frequency	50/60Hz		
Close Relay Output	16A AC250V Volts free output		
Auxiliary Relay Output	16A/7A AC250V Volts free output		
Digital Input	GND (B-) connect is active.		
Communication	RS485 isolated interface, MODBUS Protocol		
Case Dimensions	197mmx152mmx47mm		
Panel Cutout	186mmx141mm		
Working Conditions	Temperature: (-25~+70)°C; Humidity: (20~93)%RH		
Storage Condition	Temperature: (-25~+70)°C		
Protection Level	IP55 Gasket		
Insulation Strength	Apply AC2.2kV voltage between high voltage terminal and low voltage terminal; The leakage current is not more than 3mA within 1min.		
Weight	HAT700/HAT700I: 0.7kg HAT700B/HAT700BI/HAT700S: 0.8kg		

## 5 MEASURE AND DISPLAY DATA

Data Items	HAT700/HAT700B	HAT700I/HAT700BI	HAT700S
S1/S2 Phase Voltage ( L1-N,L2-N,L3-N)	•	•	•
S1/S2 Line Voltage ( L1-L2,L2-L3,L3-L1)	•	•	•
S1/S2 Phase (L1-L2-L3)	•	•	•
S1/S2 Frequency (L1)	•	•	•
3-Phase Current (I1,I2,I3)		•	•
Phase Sequence (L1-L2-L3)		•	•
3-Phase Active Power kW(P1,P2,P3)		•	•
3-Phase Total Active Power kW(P1+P2+P3)		•	•
3-Phase Reactive Power kvar (Q1,Q2,Q3)		•	•
3-Phase Total Reactive Power kvar (Q1+Q2+Q3)		•	•
3-Phase Apparent Power kVA(A1,A2,A3)		•	•
Total Apparent Power kVA(A1+A2+A3)		•	•
3-Phase Power Factor PF(PF1,PF2,PF3)		•	•
Average Power Factor PF(PF1,PF2,PF3)		•	•
Voltage Difference between S1 and S2			•
Frequency Difference between S1 and S2			•
Phase Angle between S1 and S2			•
Continuous Power Supply Time	•	•	•
Continuous Power Supply Time (Last Time)	•	•	•
S1 Total Power Supply Time	•	•	•
S2 Total Power Supply Time	•	•	•
S1 Total kW Energy kWh		•	•
S2 Total kW Energy kWh		•	•
S1 Total kvar Energy kvarh		•	•
S2 Total kvar Energy kvarh		•	•
S1 Total Close Times	•	•	•
S2 Total Close Times	•	•	•
Real Time Clock	•	•	•
Event Log	•	•	•



## 6 OPERATION











### 6.1 INDICATORS



#### INDICATORS DESCRIPTION

Indicator Type	Description
Alarm	Slow flashing (1time per sec) when warn alarm occurs. Fast flashing (5 times per sec) when fault alarm occurs.
Running	Flash when module countdown running (1time per sec)
S1 Power Normal	It is light on when S1 is normal; flashing when S1 is abnormal ((1time per sec)); off when there is no S1 power.
S1 Close Status	It is light on when S1 close input is activated.
S2 Power Normal	It is light on when S2 is normal; flashing when S2 is abnormal ((1time per sec)); off when there is no S2 power.
S2 Close Status	It is light on when S2 close input is activated.
Manual Mode	It is light on when the module is in Manual mode.
Auto Mode	It is light on when the module is in Auto mode.
Generator Start	It is light on when the Start signal is be initiated.

**6.2 KEY FUNCTION DESCRIPTION**

Icon	Button Name	Function Description
	S1 Close/Open	Active in Manual mode. Press this key, if S1 load is opened, then the S1 closing relay will be energized; if S1 load is closed, then the S1 opening relay will be energized. When sync closing is active, if S2 load is closed, press the key will energize the S1 Sync closing relay; During the S1 is waiting to synchronizing, pressing this key will de-energize the S1 sync closing relay.
	S2 Close/Open	Active in Manual mode. Press this key, if S2 load is opened, then the S2 closing relay will be energized; if S1 load is closed, then the S2 opening relay will be energized. When sync closing is active, if S2 load is closed, press the key will energize the S2 Sync closing relay; During the S2 is waiting to synchronizing, pressing this key will de-energize the S2 sync closing relay.
	Manual Mode	Set controller as Manual mode.
	Auto Mode	Set controller as Auto mode.
	Trial Run	Press this key to enter into genset manual start/stop operation interface.
	Lamp Test	Pressing and holding the key to enter lamp test mode, all LED lamps are lit and LCD screen display black.
	Alarm Reset	Press this key to enter into alarm interface; Pressing it again can clear fault alarm.
	Menu	Press this key to return the main screen; Press it again to enter into menu interface. When setting parameters, press this key to return prior menu.
	Confirm	In main screen, press this key to scroll page. In menu screen, press this key can move cursor and confirm setting information.
	Up/Increase	In main screen, press this key to scroll screen. In menu interface, press this key to up cursor or increase value in setting menu.
	Down/Decrease	In main screen, press this key to scroll screen. In menu interface, press this key to down cursor or decrease value in setting menu.

## 7 LCD DISPLAY

### 7.1 MAIN SCREEN

<b>Status</b>	
S1 Normal S2 Inactive Genset Standby S1 On Load Auto Mode	S1 Voltage Status S2 Voltage Status Genset Status Switch Status Current Mode, Alarm Status, Indications, Others
<b>Power</b>	
U1LL 380 380 380V U1LN 220 220 220V Phase 0 120 240° F1 50.00Hz BAT 27.5V Auto Mode	S1 Line Voltage (L1-L2、L2-L3、L3-L1) S1 Phase Voltage S1 Phase S1 Frequency and genset battery voltage Current Mode, Alarm Status, Indications, Others
U2LL 0 0 0V U2LN 0 0 0V Phase ##### ##### #####° F2 0.00Hz Load 100% Auto Mode	S2 Line Voltage(L1-L2、L2-L3、L3-L1) S2 Phase Voltage S2 Phase S2 Frequency and present on-load percentage. Current Mode, Alarm Status, Indications, Others
<b>Load</b>	
I 500 500 500A Phase 0 120 240° TkW 329 PF 1.00 Tkvar 1.3 TkVa 330 Auto Mode	3-phase current 3-phase current phase Total active power, power factor Total inactive power, Total apparent Power. Current Mode, Alarm Status, Indications, Others
kW 126 129 130 kvar 0.5 0.8 0.7 kVA 127 129 131 PF 1.00 1.00 1.00 Auto Mode	3-phase active power 3-phase reactive power 3-phase apparent power 3-phase power factor Current Mode, Alarm Status, Indications, Others
<b>Sync</b>	
Volt Diff. 74V x Freq Diff. 0.13Hz ok Phase Diff. 12° x Auto Mode	Volt Diff., D-value of 3-phase volt mean Freq Diff. Phase Diff. Current Mode, Alarm Status, Indications, Others
<b>Total</b>	
Cont. Power Supply Time 5:25:18 Last Cont. Powe Supply 8:15:37 Auto Mode	Cont. Power Supply Time HH: MM: SS Last Cont. Powe Supply HH: MM: SS Current Mode, Alarm Status, Indications, Others
S1 Total Supply Time 125:25:18	S1 Total Supply Time HH: MM: SS

<b>S2 Total Supply Time</b> 35:43:29 <b>Auto Mode</b>	S2 Total Supply Time HH: MM: SS Current Mode, Alarm Status, Indications, Others
<b>S1 Total kWh</b> 16263.6kWh <b>S2 Total kWh</b> 2879.9kWh <b>Auto Mode</b>	S1 Total kWh S2 Total kWh Current Mode, Alarm Status, Indications, Others
<b>S1 Total kvarh</b> 3285.5kvarh <b>S2 Total kvarh</b> 672.4kvarh <b>Auto Mode</b>	S1 Total kvarh S2 Total kvarh Current Mode, Alarm Status, Indications, Others
<b>S1 Total Close Num</b> 25 <b>S2 Total Close Num</b> 13 <b>Auto Mode</b>	S1 Total Close Times S2 Total Close Times Current Mode, Alarm Status, Indications, Others
<b>Alarms</b>	
<b>Alarms</b> 1/2 <b>Warn Alarm</b> <b>S1 Over Current</b> <b>Fault Alarm</b> <b>S1 Failed to Closed</b>	Alarm number and account Alarm type (Warn Alarm、Fault Alarm) Alarm event Alarm type (Warn Alarm、Fault Alarm) Alarm event
<b>Others</b>	
<b>S1 S2 1 2 3 4 5 6</b> <b>IN</b> <b>OUT</b> 2014-09-09(2)16:53:24 <b>Auto Mode</b>	Inputs, outputs number Input status, S1/S2 closing input, 1~4 are configurable ports Output status, S1/S2 closing output, 1~6 are configurable ports Real-time clock Current Mode, Alarm Status, Indications, Others
<b>RS485</b> <b>Address</b> 1 <b>Baud Rate</b> 9600bps <b>Stop Bit</b> 2bit <b>Auto Mode</b>	RS485 Communication Communication Address RS485 Baud Rate RS485 Stop Bit Current Mode, Alarm Status, Indications, Others

## 7.2 STATUS DESCRIPTION

### 7.2.1. S1 VOLTAGE STATUS

No.	Item	Description
1	S1 Available	S1 Normal Delay
2	S1 Unavailable	S1 Abnormal Delay
3	S1 Available	Power supply voltage is within the setting range.
4	S1 Blackout	Voltage is 0.
5	S1 Over Volt	Voltage is higher than the set value.
6	S1 Under Volt	Voltage has fallen below the set value.
7	S1 Over Freq	Frequency is higher than the set value.
8	S1 Under Freq	Frequency has fallen below the set value.
9	S1 Loss of Phase	Loss of any phase of A, B and C.
10	S1 Phase Seq Wrong	A-B-C phase sequence is wrong.

### 7.2.2. S2 VOLTAGE STATUS

No.	Item	Description
1	S2 Available	S2 Normal Delay
2	S2 Unavailable	S2 Abnormal Delay
3	S2 Available	Power supply voltage is within the setting range.
4	S2 Blackout	Voltage is 0.
5	S2 Over Volt	Voltage is higher than the set value.
6	S2 Under Volt	Voltage has fallen below the set value.
7	S2 Over Freq	Frequency is higher than the set value.
8	S2 Under Freq	Frequency has fallen below the set value.
9	S2 Loss of Phase	Loss of any phase of A, B and C.
10	S2 Phase Seq Wrong	A-B-C phase sequence is wrong.

### 7.2.3. GENSET STATUS

No.	Item	Description
1	Genset Start Delay	Delay time before genset start
2	Genset Return Delay	Delay time before genset stop
3	Scheduled Not Work	When scheduled not run is active, its duration time will be displayed.
4	Scheduled Work	When scheduled run is active, its duration time will be displayed.
5	Gen1 Cycle Run	S1 cycle run countdown will be terminated when cycle start is active.
6	Gen2 Cycle Run	S2 cycle run countdown will be terminated when cycle start is active.
7	S1 Genset Working	Active when system type is "S1 Gens S2 Gens".
8	S2 Genset Working	Active when system type is "S1 Gens S2 Gens".
9	Genset Working	Genset start signal output.
10	Genset Standby	There is no start genset signal output.

### 7.2.4. SWITCH STATUS

No.	Item	Description
1	Ready to Transfer	Switch transfer begins.
2	Closing S1	S1 closing delay is in progress.
3	Opening S1	S1 opening delay is in progress.
4	Closing S2	S2 closing delay is in progress.
5	Opening S2	S2 opening delay is in progress.
6	Transfer Rest	Interval time between switch transfer
7	Closing S1 Again	When the S1 "Fail to open" condition occurs, it's the delay time before the close relay is active for the second time.
8	Opening S1 Again	When the S1 "Fail to close" condition occurs, it's the delay time before the open relay is active for the second time.
9	Closing S2 Again	When the S2 "Fail to open" condition occurs, it's the delay time before the close relay is active for the second time.
10	Opening S2 Again	When the S2 "Fail to close" condition occurs, it's the delay time before the open relay is active for the second time.
11	Waiting Sync	It's the delay time that waiting S1 and S2 sync requirements (volt diff. freq diff. phase diff.) are satisfied.
12	Sync Closing S1	Sync closing S1 is active when the sync requirements are satisfied.
13	Sync Closing S2	Sync closing S2 is active when the sync requirements are satisfied.
14	Waiting S1 PF	Before S1 is closed, it's the delay time to confirm "S1 PF Input" signal is active.
15	Waiting S2 PF	Before S2 is closed, it's the delay time to confirm "S2 PF Input" signal is active.
16	Elevator Delay	Elevator control output before ATS transfer.
17	S1 On Load	S1 was already closed and S1 is taking load.
18	S2 On Load	S2 was already closed and S2 is taking load.
19	Offload	Switch was already opened and load is disconnect.

### 7.2.5. WARN ALARMS

Warn alarms are active when controller detects the alarm signals. Alarm indicator will flash slowly (1time per sec) while illuminated when alarm reset. Warn alarms are not latched.

No.	Item	Description
1	S1 Over Current Warn	When the S1 current has exceeded the pre-set value and the action select "Warn", it will initiate a warning alarm.
2	S2 Over Current Warn	When the S2 current has exceeded the pre-set value and the action select "Warn", it will initiate a warning alarm.
3	Forced Open Warn	When the input is active and the action select "Warn", it will initiate a warning alarm.
4	Battery Under Volt	When the battery voltage has fallen below the pre-set value, it will initiate a warning alarm.
5	Battery Over Volt	When the battery voltage has exceeded the pre-set value, it will initiate a warning alarm.
6	Sync Fail Warn	When the genset fail to sync after the "Waiting Sync" delay has expired, it will initiate a warning alarm.







### 7.2.6. FAULT ALARMS

Fault alarms are active when controller detects the alarm signals. Alarm indicator will flash rapidly (5 times per sec) and the alarm will last until it was removed manually. Fault alarms are latched.

No.	Item	Description
1	S1 Failed to Close	In Auto mode, S1 close failure is occurs.
2	S1 Failed to Open	In Auto mode, S1 open failure is occurs.
3	S2 Failed to Close	In Auto mode, S2 close failure is occurs.
4	S2 Failed to Open	In Auto mode, S2 open failure is occurs.
5	S1 Over Current Trip	When the S1 current has exceeded the pre-set value and the action select "Trip", it will initiate a fault alarm.
6	S2 Over Current Trip	When the S2 current has exceeded the pre-set value and the action select "Trip", it will initiate a fault alarm.
7	Forced Open Fault	When the input is active and the action select "Fault", it will initiate a fault alarm.
8	S1 Genset Fault	If there is "S1 fail to start" failure occurs when "S1 Gens S2 Gens" system is selected, it will initiate a fault alarm.
9	S2 Genset Fault	If there is "S2 fail to start" failure occurs when "S1 Gens S2 Gens" system is selected, it will initiate a fault alarm.
10	Switch Trip Alarm	it will initiate a fault alarm. when the input is active.
11	Sync Fail Fault	When the genset fail to sync after the "Waiting Sync" delay has expired, it will initiate a fault alarm.

### 7.2.7. INDICATION

The indication information will continuously display for 2s after it is active.

No.	Item	Description
1	Please reset the alarm	When there is fault alarm occurs, the indication will be displayed when change the genset mode to Auto Mode manually.
2	S1 was already closed.	After S1 was already closed, the indication will be displayed when "S2 close" button is pressed.
3	S2 was already closed.	After S2 was already closed, the indication will be displayed when "S1 close" button is pressed.
4	Panel Locked	When panel lock is active, the indication as pressing panel button (expect Up/Down, Confirm and lamp test button). When the input is active, the indication will be displayed when the panel button is pressed (except     .

### 7.2.8. OTHERS

No.	Item	Description
1	Start Inhibit	Genset start Inhibit is active.
2	S1 Load Inhibit	S1 Load Inhibit input is active.
3	S2 Load Inhibit	S2 Load Inhibit input is active.
4	NEL 1 Trip	NEL1 off load signal is output.
5	NEL2 Trip	NEL2 off load signal is output.
6	NEL3 Trip	NEL3 off load signal is output.
7	Remote Gen On Load	Remote start (on load) signal is active.
8	Remote Gen Off Load	Remote start (off load) signal is active.
9	Gen Start Mains NG	Start genset when mains is abnormal.
10	Cycle Gen Start Mode	Cycle Run Start Mode is active when "S1 Gens S2 Gens" system is active.
11	Balance Gen Hours Mode	Balance Run Start Mode is active when "S1 Gens S2 Gens" system is active.
12	Master-Slave Gen Start Mode	Master Run Start Mode is active when "S1 Gens S2 Gens" system is active.
13	Auto Mode	Current mode is Auto mode.
14	Manual Mode	Current mode is Manual mode.

### 7.3 MAIN MENU

In the main screen, press  key will enter into the menu interface.

2.Data Calibration 3.Historical Records 4.Start/Stop Genset 5.About	Press <b>Up/Down</b> key to choose parameters (the current line was highlighted with black) and then press <b>Confirm</b> key to enter into the corresponding display screen.
--	---

**NOTE:** Default password is 01234, user can change it in case of others change the parameters setting. Please clearly remember the password after changing. If you forget it, please contact Smartgen services.

**NOTE:** Data Calibration is for factory use only and correct passwords must be input before entered.



## 8 START/STOP OPERATION

### 8.1 MANUAL START/STOP

#### 8.1.1. PANEL START/STOP

In the main screen, press  key will enter into manual start operation interface.

<p><b>2.Stop Genset</b></p> <p><b>3.Start Genset</b></p>	<p>Press <b>Up/Down</b> key to choose parameters (the current line was highlighted with black) and then press <b>Confirm</b> key to confirm.</p>
--	--

**Genset Stop:** Disconnect the start signal, i.e. stop the running genset.

**Genset Start:** Output the start signal, i.e. start the genset.

When system is “S1 Gens S2 Gens”, manual start/stop menu interface is as follows:

<p><b>2.S1 Genset Stop</b></p> <p><b>3.S1 Genset Start</b></p> <p><b>4.S2 Genset Stop</b></p> <p><b>5.S2 Genset Start</b></p>	<p>Press <b>Up/Down</b> key to choose parameters (the current line was highlighted with black) and then press <b>Confirm</b> key to confirm.</p>
---	--

**S1 Genset Stop:** Disconnect the S1 start signal, i.e. stop the running S1 genset.

**S1 Genset Start:** Output the S1 start signal, i.e. start the S1 genset.

**S2 Genset Stop:** Disconnect the S2 start signal, i.e. stop the running S2 genset.

**S2 Genset Start:** Output the S2 start signal, i.e. start the S2 genset.

#### 8.1.2. REMOTE START/STOP

Send remote start/stop signals using MODBUS protocol via RS485 port.

**Remote Stop:** Disconnect the start signal, i.e. stop the running genset.

**Remote Start:** Output the start signal, i.e. start the genset.

### 8.2 AUTO START/STOP

#### 8.2.1 INPUT PORT START/STOP OPERATION

Set input port as “Remote Start On Load” or “Remote Start Off Load”, both could not be set simultaneously.

**Remote Start on Load:** When the input is active, genset close relay will active after genset is normal; when the input inactive, genset will stop automatically.

**Remote Start off Load:** When the input is active, mains close relay will active after mains is normal; genset close relay will active when the mains is abnormal while genset is normal; when the input inactive, genset will stop automatically.

### 8.2.2. “S1 GENS S2 GENS” START/STOP

When system is “S1 Gens S2 Gens”, input port start/stop function is as follows:

**Remote Start on Load:** Detect S1 or S2 start output according to start mode. Genset close relay will active after genset is normal.

**Remote Start off Load:** Detect S1 or S2 start output according to start mode. Both genset S1 close relay and S2 close relay are deactivated after genset start.

S1,S2 Gens Start Type: Cycs Run, Master Run, Balance Run and Not Used.

**Start Mode:** Cycle Run Start, Master Run Start, Balance Run Start.

#### **Cycle Run Start:**

When remote start is active, S1 and S2 cycle run start according to the cycle run time. At the first time to start the genset, choose “S1 Start” or “S2 Start” depends on the “Master Set” information. e.g. S1 start at the first time if “S1 Master” is selected. The S1 cycle run countdown is started according to the preset delay. At the same time, genset fault delay will be initiated. If S1 genset is normal before the fault delay has expired, S1 will take load; S2 start after the preset S1 cycle run delay has expired and the S2 loading process is same as S1. S1 will stop automatically after the S2 has take load successfully. S1 and S2 will cycle run in this way alternately until the remote start signal deactivated.

During the start process, if there is genset fault alarm (genset fault delay overtime or genset fault input is active), fail to close or load inhibit alarm occurs, the starting genset will be stop immediately and the additional genset will be start automatically.

During the cycle run process, if “Auto Mode” is selected, the current status will be hold and the “cycle run countdown” will be suspended.

#### **Master Run**

Master genset will be start when remote start signal is active. During the start process, if there is genset fault alarm (genset supply delay overtime or genset fault input is active), fail to close or load inhibit alarm occurs, the starting genset will be stop immediately and the additional genset will be start automatically. Otherwise, the master run genset will running continuously until the remote start signal deactivated.

#### **Balance Run**

The gensets which has the shortest running hours will be start when remote start signal is active. During the start process, if there is genset fault alarm (genset supply delay overtime or genset fault input is active), fail to close or load inhibit alarm occurs, the starting genset will be stop immediately and the additional genset will be start automatically. Otherwise, the current genset will running continuously until the remote start signal deactivated.

In system “S1 Gens S2 Gens” to start/stop genset should meet following several conditions:

- 1) It is active in Auto mode;
- 2) System set as “S1 Gens S2 Gens”;
- 3) Output port should be set as “S1 Genset Start” and “S2 Genset Start ”;
- 4) Input port should be set as “S1 Genset Fault Input”, “S2 Genset Fault Input” and “Remote Start On Load” or “Remote Start Off Load”;
- 5) Should set start mode when “S1 Gens S2 Gens” system is selected;
- 6) Should configure setting “Genset Supply Delay”, If start mode is cycle run, also should set “S1 Cycs Run Time” and “S2 Cycs Run Time”;

Among input ports, “S1 Genset Fault Input” and “S2 Genset Fault Input” are selective setting, Genset fault can be judged by “Genset Supply Delay” and there no need to inquire the fault alarm via input port.

When S1, S2 start type configured as “Not Used”, there is no start genset signals output

### 8.2.3. SCHEDULED RUN

Once *Scheduled Run* enables, users can set the scheduled start time. Controller will send start signal at preset start time. Start signal will deactivated after the start delay has expired.

Scheduled Run On Load or Scheduled Run Off Load can be set.

**Scheduled Run On Load:** When the input is active, genset close relay will active after genset is normal.

**Scheduled Run Off Load:** When the input is active, mains close relay will active after mains is normal; genset close relay will active when the mains is abnormal while genset is normal.

Cycle time of *Scheduled Run* can be set as start monthly, weekly and daily.

**Run Monthly:** Monthly start date and time can be set.

**Run Weekly:** Can start the genset at the same time in couple days of a week. Eg. Start the genset at 8:00 a.m. from Monday to Friday and keep 10 hours.

**Run Daily:** Can start the genset at same time everyday.

### 8.2.4. SCHEDULED NOT RUN

Once *Scheduled Not Run* enables, users can set the “scheduled not start” time. Start signal will deactivated at preset time and it will be inhibited before the delay has expired.

Cycle time of *Scheduled Not Run* can be set as monthly, weekly and daily.

**Not Run Monthly:** Monthly *Not* start Date and time can be set.



**Not Run Weekly:** Can Not start the genset at the same time in couple days of a week. Eg. Not Start the genset at 19:00 p.m. from Monday to Friday and keep 12 hours.

**Not Run Daily:** Can *Not* start the genset at same time everyday.

▲ Note: *Scheduled Not Run* operation is prior to *Scheduled Run* operation.

## 9 PARAMETERS CONFIGURATION

### 9.1 ILLUSTRATION

In the main interface, press  key, choose **Configuration** and press  again to enter into password confirmation interface. If password is correct, enter into parameter setting interface, otherwise, exit to main interface directly. Factory default password is **01234**. In parameters configuration interface, pressing  key to return the prior menu.

### 9.2 PARAMETERS TABLE

Parameters Item Table

No.	Item	Range	Default	Description
<b>AC System</b>				
1	S1 Available Delay	(0-3600) s	10	The delay from S1 voltage abnormal to normal.
2	S1 Unavailable Delay	(0-3600)s	5	The delay from S1 voltage normal to abnormal.
3	S2 Available Delay	(0-3600)s	10	The delay from S2 voltage abnormal to normal.
4	S2 Unavailable Delay	(0-3600)s	5	The delay from S2 voltage normal to abnormal.
5	Master-Slave Set	(0-2)	0	0: S1 Master 1: S2 Master 2: No Master
6	System Type Set	(0-3)	0	0: S1 Mains S2 Gen 1: S1 Gen S2 Mains 2: S1 Mains S2 Mains 3: S1 Gen S2 Gen
7	AC System	(0-3)	0	0: 3-Phase,4-Wire 1: 3-Phase,3-Wire 2: 2-Phase,3-Wire 3: Single Phase,2-Wire
8	PT Fitted	(0-1)	0	0: Disable ; 1: Enable
9	PT Primary	(30-30000)V	100	Primary voltage of voltage transformer
10	PT Secondary	(30-1000)V	100	Secondary voltage of voltage transformer
11	Rated Voltage	(0-30000)V	220	Rated voltage of AC system
12	Over Volt	(0-1)	1	0: Disable ; 1: Enable
13	Over Volt Set Value	(0-200)%	120	Upper limit value of voltage; it is abnormal if the value has exceeded the set value.
14	Over Voltage Return	(0-200)%	115	Upper limit return value of voltage; it is normal only when the value has fallen below the set value.
15	Under voltage	(0-1)	1	0: Disable ; 1: Enable
16	Under Voltage Set Value	(0-200)%	80	Lower limit value of voltage; it is abnormal if the value has fallen below the set value.



No.	Item	Range	Default	Description
17	Under Voltage Return Value	(0-200)%	85	Lower limit return value of voltage; it is normal only when the value has exceeded the set value.
18	Rated Frequency	(10.0-75.0)Hz	50.0	Rated frequency of AC system
19	Over Frequency	(0-1)	1	0: Disable ; 1: Enable
20	Over Frequency Set Value	(0-200)%	110	Upper limit value of frequency; it is abnormal if the value has exceeded the set value.
21	Over Frequency Return Value	(0-200)%	104	Upper limit return value of frequency; it is normal only when the value has fallen below the set value.
22	Under Frequency	(0-1)	1	0: Disable ; 1: Enable
23	Under Frequency Set Value	(0-200)%	90	Lower limit value of frequency; it is abnormal if the value has fallen below the set value.
24	Under Frequency Return Value	(0-200)%	96	Lower limit return value of frequency; it is normal only when the value has exceeded the set value.
25	Phase Sequence Wrong	(0-1)	1	0: Disable ; 1: Enable

**SWITCH SETTING**

1	Definite C/O Time	(0-1)	0	0: Disable ; 1: Enable Disable: The output time was judged depends on the close relay; the longest output time up to the set delay. Enable: The output time last for the preset time.
2	Close Time	(0.1-20.0)s	5.0	Pulse time of close relay.
3	Open Time	(0.1-20.0)s	5.0	Pulse time of open relay.
4	Transfer Interval	(0-9999)s	1	Interval time from S1 switch open to S2 switch close; or from S2 switch open to S1 switch close.
5	Again Close Delay	(0-20.0)s	1.0	When the breaker fail to open for the first time, then the module will close for the second time and the Again Close Delay begins, after the delay has expired, if still failed to open for the second time, the module will send out fail to open alarm.
6	Again Open Delay	(0-20.0)s	1.0	When the breaker fail to close for the first time, then the module will open for the second time and the Again Open Delay begins, after the delay has expired, if still failed to close for the second time, the module will send out fail to close alarm.
7	Switch Type	(0-2)	0	0: CB/CC (Use S1 Open and S2 Open to control) 1: PC Three-stage (PC switch with OFF position, use S1 Open to control)



No.	Item	Range	Default	Description
				2: PC Two-stage (PC switch without OFF position)
8	Forced Open Action	(0-1)	0	0: Warn Alarm 1: Fault Alarm
9	Continuously Close	(0-1)	0	0: Disable ; 1: Enable If "Enable" is selected, "Close Time" and "Open Time" are deactivated.
10	Sync Enabled	(0-1)	0	0: Disable ; 1: Enable
11	Volt diff. Enabled	(0-1)	0	0: Disable ; 1: Enable
12	Volt diff.	(0-50)V	5	It's the maximum voltage difference when the synchronization is successful.
13	Freq diff.	(0-0.50)Hz	0.20	It's the maximum frequency difference when the synchronization is successful.
14	Phase diff.	(0-20) °	5	It's the maximum phase difference when the synchronization is successful.
15	Fail to Sync Action	(0-1)	0	0: Warn Alarm 1: Fault Alarm If the "Fail to Sync" failure occurs, "Sync Waiting" signal will output continuously until the synchronization is successful. When the "Warn Alarm" is selected, the alarm will be removed after the synchronization is successful or exit. When the "Fault Alarm" is selected, the alarm will be removed only when the "Reset" button is pressed.
16	Transfer in Sync Fail	(0-1)	0	0: Disable ; 1: Enable If the "Fail to Sync" failure occurs, the alarm will <i>NOT</i> be initiated and "non-sync close" will be initiated.
17	Fail to Sync Delay	(0-9999)s	120	"Fail to Sync"alarm will be initiated after the delay has expired.
18	Breaker Feedback Time	(0.1-1.0)s	0.6	When the input is active, its delay time will be initiated. If the correct signal is detected before the delay has expired, pulse output will be terminated; If the correct signal is <i>NOT</i> detected after the delay has expired, "Fail to Close" or "Fail to Open" alarm will be initiated.
19	ATS Power Type	(0-1)	1	0: DC Power; 1: AC Power
20	ATS Power Low Point	(0-100)%	70	Lower limit voltage of switch power; The switch can not transfer when the value has fallen below the set value.
21	ATS Power High Point	(0-200)%	130	Upper limit voltage of switch power; The switch can not transfer when the value has exceeded the set value.
<b>Generator Setting</b>				
1	Gen Start Delay	(0-9999)s	1	When the genset is ready to start, start





No.	Item	Range	Default	Description
				delay begins, after the start delay has expired, start signal will be initiated.
2	Gen Stop Delay	(0-9999)s	5	When the genset is ready to stop, stop delay begins, after the stop delay has expired, stop signal will be initiated.
3	Gen-Gen Start Mode	(0-2)	0	0: Cycles Gens 1: Master-Slave Gens 2: Balance Gens Hours 3: Not Used
4	S1 Cycles Work Time	(0-9999)min	720	Gens cycle start S1 running time.
5	S2 Cycles Work Time	(0-9999)min	720	Gens cycle start S2 running time.
6	Genset Available Time	(0-9999)s	120	When the start signal is active, the start delay will be initiated. If the gen voltage lasts abnormal after the delay has expired, "Genset Fault" alarm will be initiated.
7	Battery Volt Enable	(0-1)	0	0: Disable ; 1: Enable
8	Battery LV Warn	(0-1)	0	0: Disable ; 1: Enable
9	Battery Under Volt Set Value	(0-100.0)V	10.0	"Battery Under Volts" alarm will be initiated if the battery voltage has fallen below the set value.
10	Battery Under Volt Return Value	(0-100.0)V	10.5	"Battery Under Volts" alarm will be removed if the battery voltage has exceeded the set value.
11	Battery Under Volt Delay	(0-3600)s	60	If the battery voltage has fallen below the set value, "Battery Under Volts" alarm will be initiated after the delay has expired.
12	Battery OV Warn	(0-1)	0	0: Disable ; 1: Enable
13	Battery Over Volt Set Value	(0-100.0)V	30.0	"Battery Over Volts" alarm will be initiated if the battery voltage has exceeded the set value.
14	Battery Over Volt Return Value	(0-100.0)V	29.5	"Battery Over Volts" alarm will be removed if the battery voltage has fallen below the set value.
15	Battery Over Volt Delay	(0-3600)s	60	If the battery voltage has exceeded the set value, "Battery Over Volts" alarm will be initiated after the delay has expired.
<b>Scheduler Config</b>				
1	Schedule Gen Enable	(0-1)	0	0: Disable ; 1: Enable
2	Schedule Load	(0-1)	0	0: Off Load 1: On Load
3	Schedule Period	(0-2)	0	0: Monthly 1: Weekly 2: Daily
4	Schedule Monthly	(1-31)	1	The date of start the genset
5	Schedule Weekly	(1-127)	1	Bit0: Sunday Bit1: Monday



No.	Item	Range	Default	Description
				Bit2: Tuesday Bit3: Wednesday Bit4: Thursday Bit5: Friday Bit6: Saturday
6	Schedule Hours	(0-23)h	0	The time of start the genset
7	Schedule Minutes	(0-59)min	0	
8	Schedule Work Time	(0-30000)min	30	The duration time of genset running
9	Gen Inhabit Work Set	(0-1)	0	0: Disable ; 1: Enable
10	Inhabit Period	(0-2)	0	0: Monthly 1: Weekly 2: Daily
11	Inhabit Monthly	(1-31)	1	The date of <i>NOT</i> start the genset
12	Inhabit Weekly	(1-127)	1	Bit0: Sunday Bit1: Monday Bit2: Tuesday Bit3: Wednesday Bit4: Thursday Bit5: Friday Bit6: Saturday
13	Inhabit Hours	(0-23)	0	The time of <i>NOT</i> start the genset
14	Inhabit Minutes	(0-59)	0	
15	Inhabit Rest Time	(0-30000)	30	The duration time of genset <i>NOT</i> running
<b>Load Setting</b>				
1	Current CT Enable	(0-1)	1	0: Disable ; 1: Enable
2	CT Primary/5	(5-6000)A	500	The primary current of CT.
3	S1 Full Load Rating	(5-6000)A	500	The current of S1 taking full load
4	S2 Full Load Rating	(5-6000)A	500	The current of S2 taking full load
5	S1 Max kW Rating	(1-20000)kW	200	The maximum active power of S1 taking load
6	S2 Max kW Rating	(1-20000)kW	200	The maximum active power of S2 taking load
7	Over Current Enable	(0-1)	1	0: Disable ; 1: Enable
8	Over Current	(0-200)%	120	Over current set value
9	Over Current Action	(0-1)	0	0: Warn 1: Trip
10	Over Current Type	(0-1)	0	0: Definite Time 1: Inverse Definite
11	Over Current Delay	(0-3600)s	10	It's the over current delay time when "Definite Time" is selected.
12	Multiply	(1-36)	36	It's the over current multiply when "IDMT" is selected.
13	Elevator Enable	(0-1)	0	0: Disable ; 1: Enable
14	Elevator Delay	(0-300)s	300	It's the delay time before the load disconnect or switch transfer. Used for control the running elevator stop at the nearest floor until the switch transfer is terminated.
15	NEL Enable	(0-1)	0	0: Disable ; 1: Enable





No.	Item	Range	Default	Description
16	NEL1 Set Value	(0-200)%	90	Off load output will active if the load power has exceeded the set value and the delay time has expired.
17	NEL1 Delay	(0-3600)s	5	
18	NEL2 Set Value	(0-200)%	100	Off load output will active if the load power has exceeded the set value and the delay time has expired.
19	NEL2 Delay	(0-3600)s	1	
20	NEL Return Enable	(0-1)	0	0: Disable ; 1: Enable
21	NEL Return Set Value	(0-200)%	50	NEL control will deactivated if the load power has fallen below the set value and the delay time has expired.
22	NEL Return Delay	(0-3600)s	5	
23	NEL Num	(1-3)	3	NEL number
24	Mains Load NEL Enable	(0-1)	0	0: Disable ; 1: Enable
<b>Digital Input</b>				
1	Digital Input 1	(0-29)	1	Forced Open
2	Active Type	(0-1)	0	0: Closed to active; 1: Open to active
3	Digital Input 2	(0-29)	8	Switch Trip Input
4	Active Type	(0-1)	0	0: Closed to active; 1: Open to active
5	Digital Input 3	(0-29)	0	Not Used
6	Active Type	(0-1)	0	0: Closed to active; 1: Open to active
7	Digital Input 4	(0-29)	0	Not Used
8	Active Type	(0-1)	0	0: Closed to active; 1: Open to active
<b>Relay Output</b>				
1	Relay Output 1	(0-1)	0	0:Normally open; 1:Normally close
2	Contents Setting	(0-92)	49	ATS Power L1
3	Relay Output 2	(0-1)	0	0:Normally open; 1:Normally close
4	Contents Setting	(0-92)	52	ATS Power N
5	Relay Output 3	(0-1)	0	0:Normally open; 1:Normally close
6	Contents Setting	(0-92)	35	S1 Open Control
7	Relay Output 4	(0-1)	0	0:Normally open; 1:Normally close
8	Contents Setting	(0-92)	37	S2 Open Control
9	Relay Output 5	(0-1)	0	0:Normally open; 1:Normally close
10	Contents Setting	(0-92)	1	Custom Combined 1
11	Relay Output 6	(0-1)	0	0:Normally open; 1:Normally close
12	Contents Setting	(0-92)	32	Genset Start Output
13	Combined 1 Or Out 1	(0-1)	0	0:Normally open;





No.	Item	Range	Default	Description
	Active Type			1:Normally close
14	Combined 1 Or Out 1 Contents Setting	(0-92)	23	S1 Normal
15	Combined 1 Or Out 2 Active Type	(0-1)	0	0:Normally open; 1:Normally close
16	Combined 1 Or Out 2 Contents Setting	(0-92)	25	S2 Normal
17	Combined 1 And Out Active Type	(0-1)	1	0:Normally open; 1:Normally close
18	Combined 1 And Out Contents Setting	(0-92)	0	Not Used
19	Combined 2 Or Out 1 Active Type	(0-1)	0	0:Normally open; 1:Normally close
20	Combined 2 Or Out 1 Contents Setting	(0-92)	0	Not Used
21	Combined 2 Or Out 2 Active Type	(0-1)	0	0:Normally open; 1:Normally close
22	Combined 2 Or Out 2 Contents Setting	(0-92)	0	Not Used
23	Combined 2 And Out Active Type	(0-1)	0	0:Normally open; 1:Normally close
24	Combined 2 And Out Contents Setting	(0-92)	0	Not Used
25	Combined 3 Or Out 1 Active Type	(0-1)	0	0:Normally open; 1:Normally close
26	Combined 3 Or Out 1 Contents Setting	(0-92)	0	Not Used
27	Combined 3 Or Out 2 Active Type	(0-1)	0	0:Normally open; 1:Normally close
28	Combined 3 Or Out 2 Contents Setting	(0-92)	0	Not Used
29	Combined 3 And Out Active Type	(0-1)	0	0:Normally open; 1:Normally close
30	Combined 3 And Out Contents Setting	(0-92)	0	Not Used
31	Combined 4 Or Out 1 Active Type	(0-1)	0	0:Normally open; 1:Normally close
32	Combined 4 Or Out 1 Contents Setting	(0-92)	0	Not Used
33	Combined 4 Or Out 2 Active Type	(0-1)	0	0:Normally open; 1:Normally close
34	Combined 4 Or Out 2 Contents Setting	(0-92)	0	Not Used
35	Combined 4 And Out Active Type	(0-1)	0	0:Normally open; 1:Normally close
36	Combined 4 And Out	(0-92)	0	Not Used



No.	Item	Range	Default	Description
	Contents Setting			
37	Combined 5 Or Out 1 Active Type	(0-1)	0	0:Normally open; 1:Normally close
38	Combined 5 Or Out 1 Contents Setting	(0-92)	0	Not Used
39	Combined 5 Or Out 2 Active Type	(0-1)	0	0:Normally open; 1:Normally close
40	Combined 5 Or Out 2 Contents Setting	(0-92)	0	Not Used
41	Combined 5 And Out Active Type	(0-1)	0	0:Normally open; 1:Normally close
42	Combined 5 And Out Contents Setting	(0-92)	0	Not Used
43	Combined 6 Or Out 1 Active Type	(0-1)	0	0:Normally open; 1:Normally close
44	Combined 6 Or Out 1 Contents Setting	(0-92)	0	Not Used
45	Combined 6 Or Out 2 Active Type	(0-1)	0	0:Normally open; 1:Normally close
46	Combined 6 Or Out 2 Contents Setting	(0-92)	0	Not Used
47	Combined 6 And Out Active Type	(0-1)	0	0:Normally open; 1:Normally close
48	Combined 6 And Out Contents Setting	(0-92)	0	Not Used
<b>Module Setting</b>				
1	Power On Mode	(0-2)	0	0: Previous Mode (Keep the working mode last time running) 1: Manual 2: Auto
2	Module Address	(1-254)	1	RS485 communication address
3	Language	(0-2)	0	0: Chinese 1: English 2: Others (Language can be set via PC software)
4	Password	(00000-65535)	01234	For entering parameters setting.
5	Baud Rate	(0-3)	2	0:2400 1:4800 2:9600 3:19200
6	Stop Bit	(1-2)	2	2 stop bits or 1 stop bit can be set.
7	Date and Time			

### 9.3 INPUT/OUTPUT FUNCTION DESCRIPTION

#### 9.3.1 INPUT PORTS FUNCTION

No.	Item	Description
0	Not used	Invalid
1	Forced Open	No matter the genset is in manual mode or Auto mode, when the input is active, this will force the breaker to transfer the ATS to OFF position. "No Breaking" ATS is unavailable.
2	Remote Start on Load	When active, controller will send genset start signal immediately. When mains is normal, genset will close the breaker.
3	Remote Start Off Load	When active, controller will send a genset start signal immediately. When mains is normal, genset will not close the breaker.
4	Test lamp	When active, all LED lights on the front panel are illuminated and the backlight of the LCD is illuminated while the LCD screen is black in color.
5	Gen1 Fault Input	In Cycle start, if the input is active, S1 Gens start will be inhibited.
6	Gen2 Fault Input	In Cycle start, if the input is active, S2 Gens start will be inhibited.
7	Start Inhibit Input	In Auto mode, start signal will deactivated after the stop delay has expired. In Manual mode, if the genset is running, users should stop it manually; then the manual start signal will deactivated.
8	Breaker Trip Input	Trip failure input
9	S1 Close Inhibit	In Manual mode, S1 manual close is inhibited; if breaker already closed, users should open it manually. In Auto mode, if breaker already closed, then close relay will deactivated or S2 take load.
10	S2 Close Inhibit	In Manual mode, S2 manual close is inhibited; if breaker already closed, users should open it manually. In Auto mode, if breaker already closed, then close relay will deactivated or S1 take load.
11	S1 Breaker PF Input	When the S1 PF input is active, S1 close relay will activated.
12	S2 Breaker PF Input	When the S2 PF input is active, S2 close relay will activated.
13	S1 O/C Key	Simulate the panel S1 O/C button to control the S1 close/open. Self-reset button is recommended.
14	S2 O/C Key	Simulate the panel S2 O/C button to control the S2 close/open. Self-reset button is recommended.
15	Alarm Reset	Reset the current alarm.
16	Alarm Mute	Silence the audible alarm.
17	NEL Trip Key	Control the NEL off load manually. Self-reset button is recommended.
18	NEL Return Key	Control the NEL on load again manually. Self-reset button is recommended.
19	S1 Master Input	Set S1 master use compulsively.
20	S2 Master Input	Set S2 master use compulsively.
21	Forced Manual Mode	Set the controller in Manual mode compulsively.
22	Forced Auto Mode	Set the controller in Auto mode compulsively.
23	Panel Lock	Panel button operation are inhibited (Except    and



		OK).
24	Sync Inhibit	Sync transfer function is deactivated.
25	Scheduler Inhibit	Schedule Start and Schedule Not Start function are deactivated.
26	Simulate S1 OK	Simulate S1 voltage is normal; the S1 voltage abnormal delay is deactivated.
27	Simulate S2 OK	Simulate S2 voltage is normal; the S2 voltage abnormal delay is deactivated.
28	Reserved	
29	Reserved	

### 9.3.2 OUTPUT PORTS FUNCTION

No.	Items	Description
0	Not Used	Invalid
1	Custom Period 1	
2	Custom Period 2	
3	Custom Period 3	
4	Custom Period 4	
5	Custom Period 5	
6	Custom Period 6	
7	Reserved	
8	Reserved	
9	Reserved	
10	Reserved	
11	Common Alarm	It includes fault alarm and warn alarm.
12	Common Fault Alarm	It includes Transition Fault alarm and Over Current alarm.
13	Common Warn Alarm	It includes S1 Phase Sequence Wrong alarm, S2 Phase Sequence Wrong alarm, Over Current and Forced Open alarm.
14	Transition Fault	It includes S1 Fail to Close alarm, S1 Fail to Open alarm, S2 Fail to Close alarm, S2 Fail to Open alarm,.
15	Audible Alarm	Action when common alarm occurs. Can be connected annunciator externally. When "alarm mute" input is active or 60s delay has expired, it can remove the alarm.
16	Reserved	
17	Genset Start Delay	Output when start signal is initiated.
18	Genset Stop Delay	Output when stop signal is initiated.
19	Elevator Control	Output before the load disconnect or switch transfer. Used for control the running elevator stop at the nearest floor until the switch transfer is terminated.
20	Reserved	
21	Reserved	
22	Reserved	
23	S1 Available	Output when S1 power is normal.
24	S1 Unavailable	Output when S1 power is abnormal.
25	S2 Available	Output when S2 power is normal.
26	S2 Unavailable	Output when S2 power is abnormal.



27	S1 Over Current	Output when S1 over current occurs.
28	S2 Over Current	Output when S2 over current occurs.
29	Reserved	
30	Auto Mode	Output when the genset is in Auto mode.
31	Manual Mode	Output when the genset is in Manual mode.
32	Genset Start Output	Control the genset to start.
33	Reserved	
34	S1 Close Control	Control the S1 switch to close.
35	S1 Open Control	Control the S1 switch to open. If PC Three-stage is selected, it also control the S2 switch to open.
36	S2 Close Control	Control the S2 switch to close.
37	S2 Open Control	Control the S2 switch to open.
38	Reserved	
39	Reserved	
40	NEL1 Trip	Control the NEL off load when the output is active; It can control the NEL on load again when the output deactivated.
41	NEL2 Trip	
42	NEL3 Trip	
43	Reserved	
44	Reserved	
45	Breaker1 On Feedback	The close status of S1 switch
46	Breaker2 On Feedback	The close status of S2 switch
47	S1 Genset Start	When the system type is "S1 Gen S2 Gen", it controls the S1 genset start.
48	S2 Genset Start	When the system type is "S1 Gen S2 Gen", it controls the S2 genset start.
49	ATS Power L1	ATS power supply
50	ATS Power L2	
51	ATS Power L3	
52	ATS Power N	
53	Remote Control	Control the output via RS485 command.
54	Input 1 Status	Input status
55	Input 2 Status	
56	Input 3 Status	
57	Input 4 Status	
58	Reserved	
59	Reserved	
60	Reserved	
61	Reserved	
62	Reserved	
63	Reserved	
64	S1 Blackout	S1 power supply status
65	S1 Over Volt	
66	S1 Under Volt	
67	S1 Over Freq	
68	S1 Under Freq	





69	S1 Loss Of Phase	
70	S1 Phase Seq Wrong	
71	Reserved	
72	Reserved	
73	S2 Blackout	S2 power supply status
74	S2 Over Volt	
75	S2 Under Volt	
76	S2 Over Freq	
77	S2 Under Freq	
78	S2 Loss Of Phase	
79	S2 Phase Seq Wrong	
80	Reserved	
81	Reserved	
82	Sync Fail	Output when the synchronization is failed.
83	Sync Waiting	Output when the genset is waiting for synchronization.
84	Switching	Output during the switch transfer process.
85	Battery Under Volt	Output when battery under voltage alarm occurs.
86	Battery Over Volt	Output when battery over voltage alarm occurs.
87	Gen Inhibit Work	Output during the Schedule Not Run process.
88	Scheduler Gen Start	Output during the Schedule Run process.
89	Reserved	
90	Reserved	
91	Reserved	
92	Reserved	

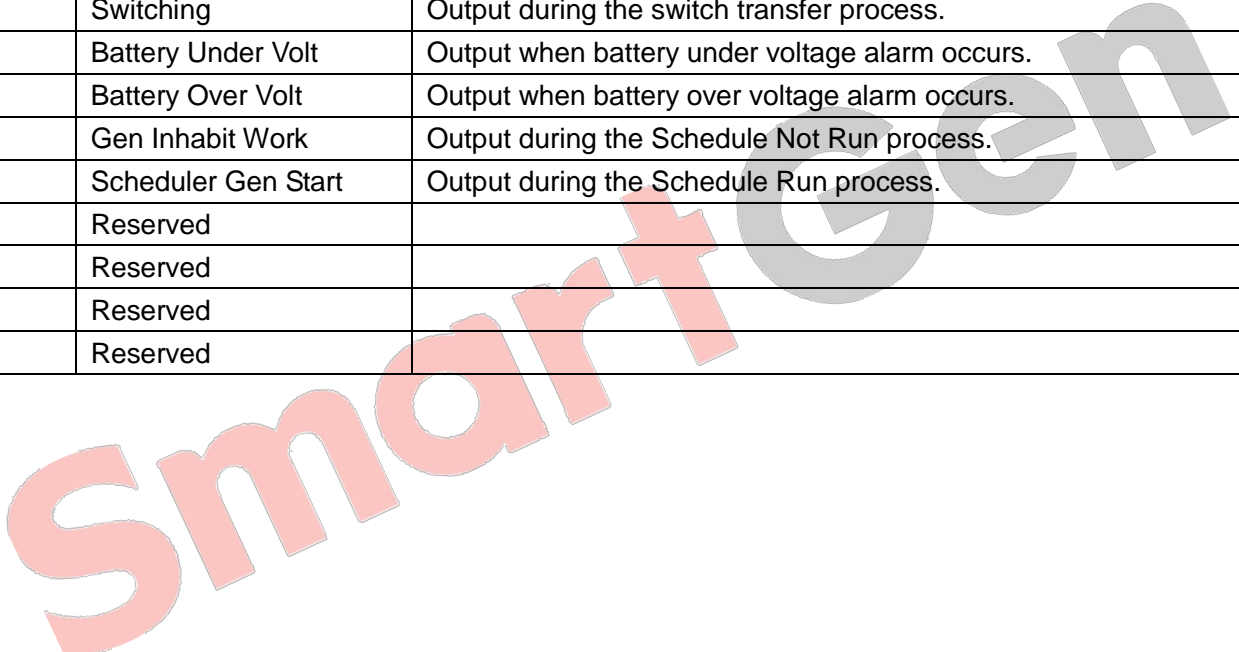

### 9.3.3 CUSTOM PERIOD OUTPUT

Defined combination output is composed by 3 parts, condition output SW1 or SW2 and condition output SW3.

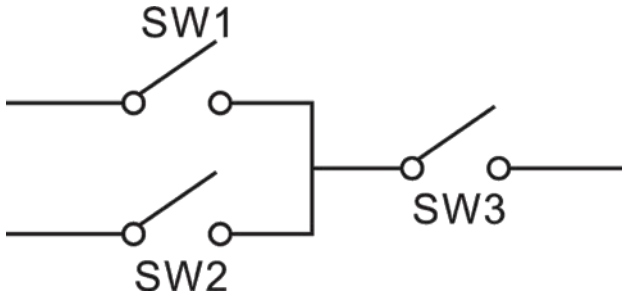

SW1 or SW2 is **TRUE**, while SW3 is **TRUE**, Defined combination output is active;

SW1 and SW2 are **FALSE**, or SW3 is **FALSE**, Defined combination output is deactivated.

**NOTE:** SW1, SW2, SW3 can be set as any contents except for “defined combination output” in the output setting.

**NOTE:** 3 parts of defined combination output (SW1, SW2, SW3) couldn't include or recursively include themselves.

Example,

Contents of probably condition output SW1: output port 1 is active;

Close when probably condition output SW1 is active /inactive: close when active (disconnect when inactive);

Contents of probably condition output SW2, output port 2 is active;

Close when probably condition output SW2 is active /inactive: close when active (disconnect when inactive);

Contents of probably condition output SW3: output port 3 is active;

Close when probably condition output SW3 is active /inactive: close when active (disconnect when inactive);

When input port 1 active or input port 2 active, if input port 3 is active, Defined combination output is outputting; If input port 3 inactive, Defined combination output is not outputting;

When input port 1 inactive and input port 2 inactive, whatever input port 3 is active or not, Defined combination output is not outputting.



#### 9.4 DEFINITE TIME DELAY AND INVERSE DEFINITE MINIMUM TIME SETTING

Definite Time: overcurrent delay is definite time delay. Different overcurrent value has corresponding delay.

Inverse Definite Minimum Time(IDMT): overcurrent delay decrease with the increase of overcurrent. Different overcurrent value has corresponding delay.

IDMT formula:

$$T = t / ((IA/IT)-1)^2$$

T: Overcurrent delay (second)

t: Timing multiplier ratio

IA: Current max. load current (L1/L2/L3)

IT: Overcurrent setting value

Example:

t = 36



IA = 550A















IT =500A

Conclusion: T = 3600s(1hour)

SmartGen

## 10 EVENT LOG

On the main screen press  key and select **Event log**, and then press  key again, the screen will show the event log interface as follow:

After enter into the "Event Log" interface, press  /  to view records.	
<b>Action Event</b>  /99 <b>S1Genset Start</b> <b>S1 Inactive</b> <b>S2 Inactive</b> <b>2014-09-12 16:57:26</b>	Alarm type, number and total count. Event Log; S1Power supply status; S2 Power supply status; Date and time;
Press  to view the detailed record information; press it again to exit the current record.	
  <b>S1 Inactive</b> <b>S2 Normal</b> <b>2014-09-12 16:57:26</b>	Alarm type, number and total count. Event Log; S1Power supply status; S2 Power supply status; Date and time;
Press  /  to view the detailed record information; press it again to exit the current record.	
  <b>U1LN 0 0 0V</b> <b>U2LN 220 221 219V</b> <b>F1 0.00Hz F2 0.00Hz</b>	Alarm type, number and total count. Event Log; S1 Phase Voltage; S2 Phase Voltage; S1 Frequency, S2 Frequency;
Press  /  to view the detailed record information; press it again to exit the current record.	
  <b>I 130 145 136A</b> <b>TkW 220 PF 1.00</b>	Alarm type, number and total count. Event Log; Load Current; Active Power and Power Factor;

Event log includes: event log type, event log, S1 power supply, S2 power supply, S1 3-phase voltage, S2 3-phase voltage, S1 frequency, S2 frequency, load current, active power, power factor and the record date and time.

Event log type includes: Action Event, Warn Event and Fault Event. All fault event actions are fault alarm while all warn event actions are warn alarm.







Action events are as follows:

No.	Action Events	Description
1	Closing S1	Record when the S1 close relay activated.
2	Closing S2	Record when the S2 close relay activated.
3	Opening	Record when the open relay (S1 Open or S2 Open) activated.
4	Sync Closing S1	Record when the S1 sync close relay activated.
5	Sync Closing S2	Record when the S2 sync close relay activated.
6	NEL1 Trip	Record when the NEL 1 Trip output.
7	NEL2 Trip	Record when the NEL 2 Trip output.
8	NEL3 Trip	Record when the NEL 3 Trip output.
9	Genset Start	Record when the Genset Start signal output.
10	S1 Genset Start	Record when the S1 Genset Start signal output.
11	S2 Genset Start	Record when the S2 Genset Start signal output.
12	Genset Stop	Record when the Genset Start signal deactivated.
13	S1 Genset Stop	Record when the S1 Genset Start signal deactivated.
14	S2 Genset Stop	Record when the S2 Genset Start signal deactivated.
15	Auto Mode	Record when the genset mode transferred to Auto Mode.
16	Manual Mode	Record when the genset mode transferred to Module Mode.

## 11 ATS OPERATION

### 11.1 MANUAL OPERATION

Manual mode is selected by pressing the  button; a LED besides the button will illuminate to confirm the operation.

- Press S1  button, S1 close relay will active, after the close delay has expired, S1 close relay will deactivated and the S1 take load. Press S1  button again (Invalid for the ATS without Open Control), S1 open relay will active, after the open delay has expired, S1 open relay will deactivated and the S1 off load.
- Press S2  button, S2 close relay will active, after the close delay has expired, S2 close relay will deactivated and the S2 take load. Press S2  button again (Invalid for the ATS without Open Control), S2 open relay will active, after the open delay has expired, S2 open relay will deactivated and the S2 off load.

### 11.2 AUTOMATIC OPERATION

Auto mode is selected by pressing the  button; a LED besides the button will illuminate to confirm the operation. The controller will select S1 power or S2 power according to the preset “master set” and control the genset to start according to the preset conditions.

### 11.3 SYNC CLOSING

If both of S1 Power and S2 power are normal, “**Sync Closing**” means transfer the load from the current power to the other power after the synchronization requirements have reached.

**Sync Closing:** If “Sync Closing” is enabled, its function will active; otherwise, “Sync Closing” function will *Not* be implemented.

**Volt Difference:** It’s the maximum voltage difference between S1 and S2 during “Sync Closing”. If “Volt Difference” is disabled, then the voltage difference will not be detected during “Sync Closing”.

**Freq Difference:** It’s the maximum frequency difference between S1 and S2 during “Sync Closing”.

**Phase diff.:** It’s the maximum phase difference between S1 and S2 during “Sync Closing”. In general, the phase difference value should not be too large in order to avoid the too large load shock when closing.

**Fail to Sync Action:** Can be set as “Warn Alarm” or “Fault Alarm”. If the “Fail to Sync” failure occurs, “Sync Waiting” signal will output continuously until the synchronization is successful. When the “Warn Alarm” is selected, the alarm will be removed after the synchronization is successful or exit. When the “Fault Alarm” is selected, the alarm will be removed only when the “Reset” button is pressed.

**Fail Sync Coercion Close:** If it is enabled, when the “Fail to Sync” failure occurs, the alarm will *NOT* be initiated and “non-sync close” will be initiated.

**Fail to Sync Delay:** “Fail to Sync” alarm will be initiated after the delay has expired.

**Sync Transfer Time:** When the input is active, its delay time will be initiated. If the correct signal is detected before the delay has expired, pulse output will be terminated; If the correct signal is *NOT*

detected after the delay has expired, “Fail to Close” or “Fail to Open” alarm will be initiated.

**Sync Transfer Diagram :**

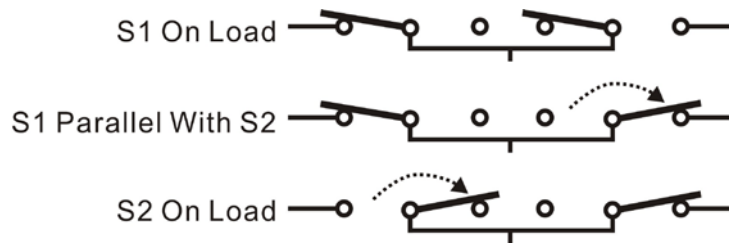

**S1 Sync Closing:**

If both of S1 Power and S2 power are normal, S2 has taken load, then S1 close relay will active until S1 close signal is detected or “Sync Transfer Time” has expired; After that, S1 close relay will deactivated. At the same time, S2 open relay will active until S2 open signal is detected or “Sync Transfer Time” has expired; then S2 open relay will deactivated.

During the synchronization process, if Close (or Open) action is not successful after the “Sync Transfer Time” has expired, “Fail to Close” or “Fail to Open” alarm will be initiated.

**S1 Sync Closing Diagram:**

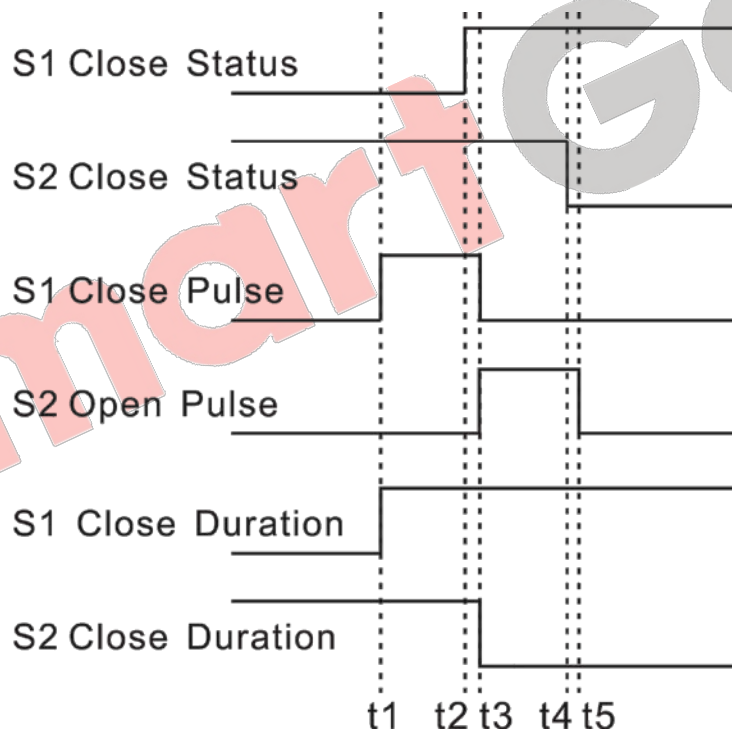

**S2 Sync Closing:**



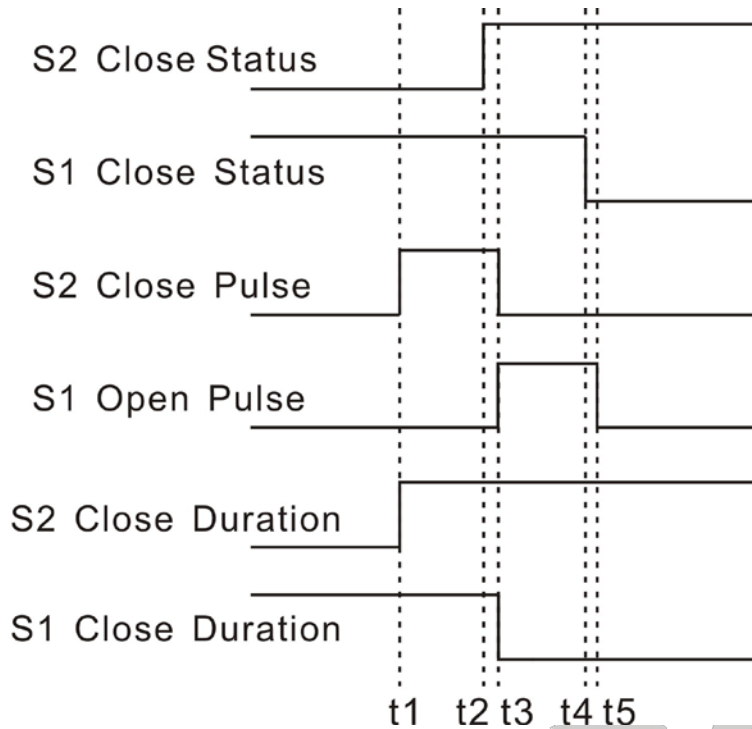

If both of S1 Power and S2 power are normal, S1 has taken load, then S2 close relay will active until S2 close signal is detected or “Sync Transfer Time” has expired; After that, S2 close relay will deactivated. At the same time, S1 open relay will active until S1 open signal is detected or “Sync Transfer Time” has expired; then S1 open relay will deactivated.

During the synchronization process, if Close (or Open) action is not successful after the “Sync Transfer Time” has expired, “Fail to Close” or “Fail to Open” alarm will be initiated.

**S2 Sync Closing Diagram:**



**MANUAL SYNC CLOSING**

In Manual mode, both of S1 Power and S2 power are normal: if S1 has taken load, press S2  button will lead S2 sync closing; if S2 has taken load, press S1  button will lead S1 sync closing. During “Waiting Sync” process, press  again will stop Sync Closing; Long pressing  button will initiate “Non-sync Closing” operation immediately. If synchronization is not successful after the “Waiting Sync” delay has expired, “Fail to Sync” alarm will be initiated while “Sync Waiting” signal will output continuously until the synchronization is successful or press  to cancel the operation.

**AUTO SYNC CLOSING**

In Auto mode, if backup power is normal and it is already closed, after master power return to normal, it will sync closing.



Warn: After the “Sync Closing” is active, S1 and S2 paralleling situations that may arise. If “S1 Mains S2 Mains” system is selected, please make sure the switch are self-locking to avoid the S1 and S2 closed simultaneously. Otherwise, damage the switch and circuit, or endanger personal safety situation may happen.

## 12 ATS POWER SUPPLY

Switch Power Type can be set as DC Power or AC Power. If DC Power is selected, then the switch can be transferred at any time (even when both S1 and S2 are outage). If AC Power is selected, whether the power is normal or not should be judged according to the ATS power setting and AC power voltage.

The power of ATS is supplied by controller, as long as one power is normal, this can ensure ATS voltage power supply normally and can be transferred properly.

Users should select power supply voltage (phase voltage or line voltage) based on ATS type. If choose phase voltage, connect the phase voltage of S1 and S2 (e.g. A phase) to normally close (Pin5) and normally open (Pin7) contact of auxiliary output 1; connect N phase of S1 and S2 to normally close (Pin8) and normally open (Pin10) contact of auxiliary output 2. And then connect the common output of auxiliary output 1 and auxiliary output 2 to ATS power supplies. Enter into the parameter setting interface, set the configurable output 1 as "ATS power L1" while set the configurable output 2 as "ATS power N". If the ATS power supplied by Line Voltage, same procedures as above but change phase N to phase voltage and the auxiliary output 2 should be configured according to the set. Wiring diagrams are shown as following:

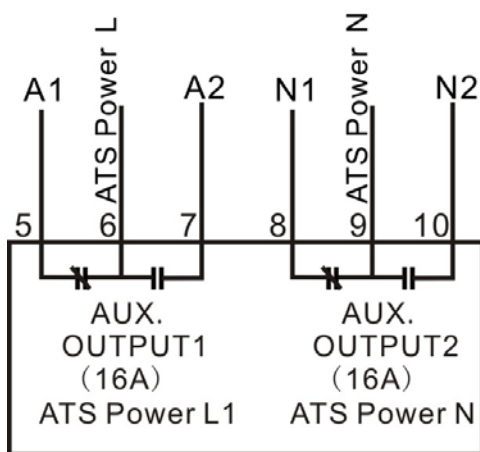

ATS phase voltage power supply

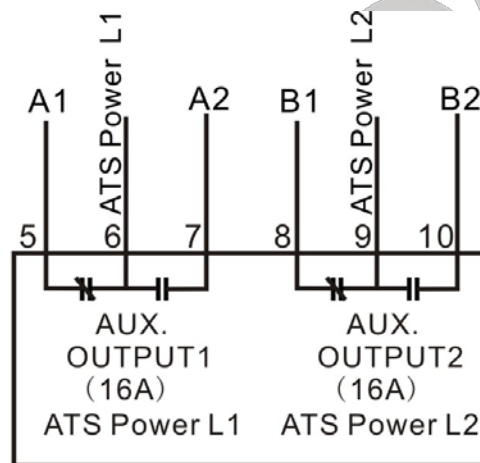

ATS line voltage power supply

**Note:** Normally Close (N/C) input voltage must come from S1 voltage.

**Note:** ATS Close/Open relay will active only when the ATS power is normal. If ATS Power output port is not configured, then the ATS power is supplied by L1-N phase (system default).



### 13 LOAD SHEDDING

Non-essential load ---- NEL for short.

The controller can control the NEL1, NEL2 and NEL3 to trip separately. The order of the essentiality is: NEL3 > NEL2 > NEL1

◆ **Auto trip:**

When NEL auto trip is enabled:

If the genset power has exceed the NEL trip value, after the trip delay, NEL1 will trip the earliest, and then is NEL2, NEL3;

When NEL auto reconnection is enabled:

If the genset power has fallen below the auto reconnection set value, after the auto reconnection delay, NEL3 will reconnection the earliest, and then is NEL2, NEL1;

- t1: NEL Trip Delay
- t2: Reconnection Delay

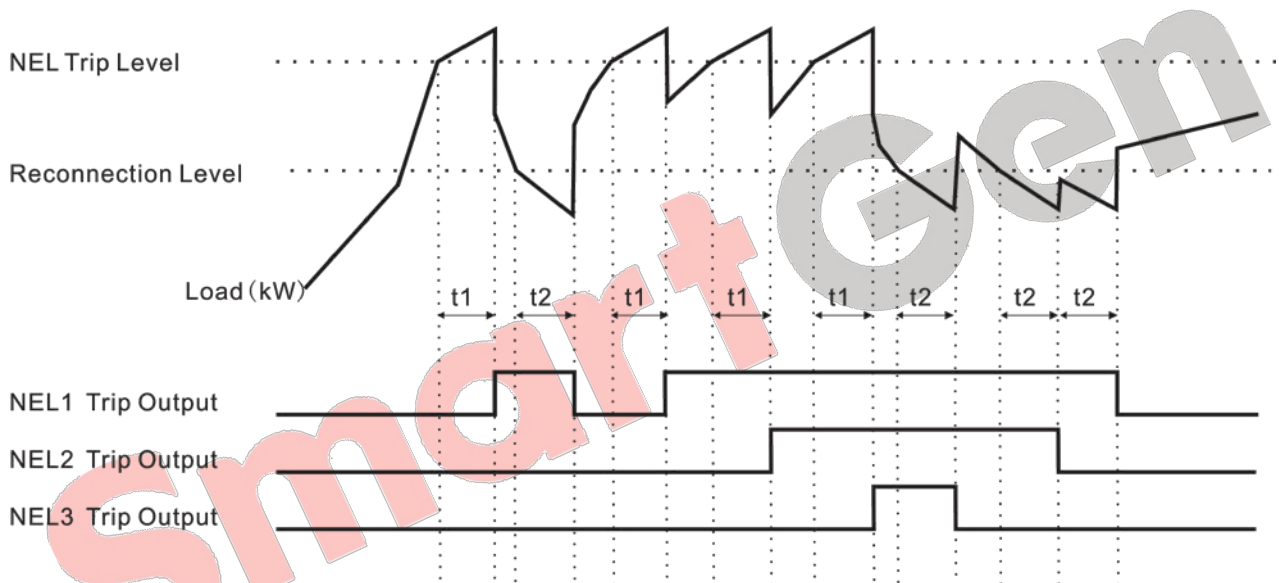

◆ **Manual Trip**

If NEL manual trip input is active (earthed failing edge is active), NEL1 will trip without delay; If NEL manual trip input is active again, NEL2 will trip; If NEL manual trip input is active the third time, NEL3 will trip. During this process, the controller do not detect if the genset power has exceed the NEL trip value or not.

If NEL manual reconnection input is active (earthed failing edge is active), NEL3 will reconnect without delay; If NEL manual reconnection input is active again, NEL2 will reconnect; If NEL manual reconnection input is active the third time, NEL1 will reconnect. During this process, the controller detects the genset power: if the genset power has fallen below the NEL reconnection value, then the input is active; if it doesn't, the input is deactivated.

▲Note: When auto trip and auto reconnection are enabled, manual trip is still active.



## 14 COMMUNICATION CONFIGURATION

HAT700 series controller equips with RS485 serial port which enable the connection of LAN. It uses Modbus protocol via PC or system software, it can also be applicable to dual power switching management to factories, telecom, industrial and civil buildings, which achieves “remote control, remote measuring, remote communication” functions.

More information of Communication Protocol, please refer to “HAT600 Communication Protocol”.

### Communication parameters:

Module address     1 (range: 1-254, User can set it)  
 Baud rate           9600 bps (2400/4800/9600/19200bps)  
 Data bit             8bit  
 Parity bit           None  
 Stop bit             1 bit or 2-bits

## 15 DESCRIPTION OF CONNECTING TERMINALS

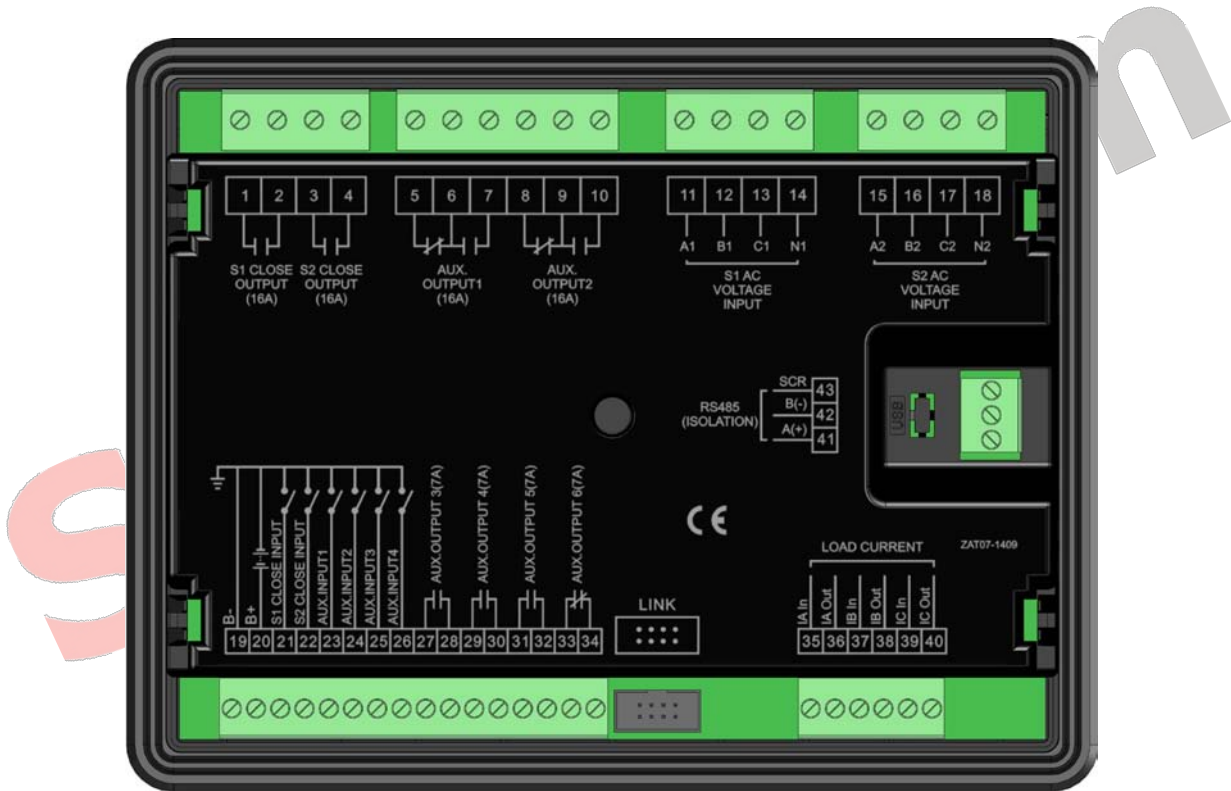

### Terminal description,

NO.	Items	Description	Remark
1	S1Close Output	Volts free; Relay contact; Normally	Capacity: 250V 16A
2		Open output	
3	S2 Close Output	Volts free; Relay contact; Normally	Capacity:250V16A
4		Open output	
5	Aux. Output 1	Normally Close	Default: ATS Power Volts free; Relay contact Output Capacity: 250V16A
6		COM	
7		Normally Open	
8	Aux. Output 2	Normally Close	Default: ATS Power Volts free; Relay contact Output



NO.	Items	Description	Remark	
9		COM	Capacity: 250V16A	
10		Normally Open		
11	A1	S1 AC System 3P4W voltage input	For single phase, only connect A1, N1	
12	B1			
13	C1			
14	N1			
15	A2	S2 AC System 3P4W voltage input	For single phase, only connect A2, N2	
16	B2			
17	C2			
18	N2			
19	B-	Connected with negative of starter battery.	Ground terminal	
20	B+	Connected with positive of starter battery.	DC(8-35)V; Power supplied by controller.	
21	S1 Close Output	Detect the S1 ATS closing status. Volts free contact input.	Ground connected is active.	
22	S2 Close Output	Detect the S2 ATS closing status. Volts free contact input.	Ground connected is active.	
23	Aux. Input 1	User-defined.	Ground connected is active.	
24	Aux. Input 2		Ground connected is active.	
25	Aux. Input 3		Ground connected is active.	
26	Aux. Input 4		Ground connected is active.	
27	Aux. Output 3	Volts free; Relay contact; Normally Open output	Capacity: 250V7A	
28				
29	Aux. Output 4	Volts free; Relay contact; Normally Open output	Capacity: 250V7A	
30				
31	Aux. Output 5	Volts free; Relay contact; Normally Open output	Capacity: 250V7A	
32				
33	Aux. Output 6	Volts free; Relay contact; Normally Close output Default: Genset Start Output	Capacity: 250V7A	
34				
35	IA In	CT Secondary A-Phase current input	Only suitable for HAT700I/HAT700BI	
36	IA Out			
37	IB In	CT Secondary B-Phase current input		
38	IB Out			
39	IC In	CT Secondary C-Phase current input		
40	IC Out			
41	RS485 A+	RS485 Communication Port		120Ω impedance matched resistance should be connected according to the different situation.
42	RS485 B-			
43	RS485			
LINK	Programming Port	Used for PC program updating.		

**16 TYPICAL WIRING DIAGRAM**

ATYS3 Wiring Diagram

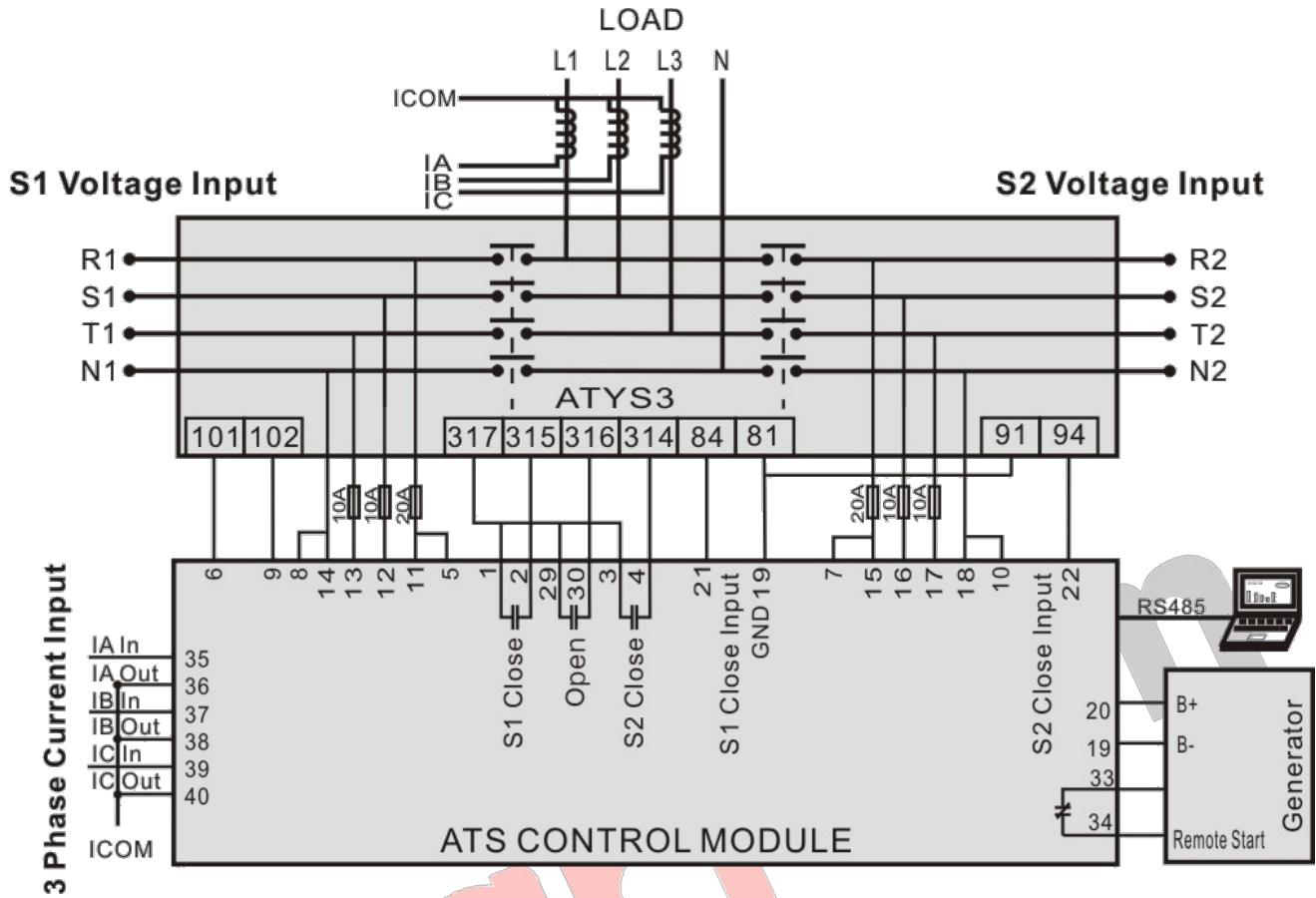

Parameters Setting	
Switch Type	PC Three-stage
Aux. Output 1	ATS Power L
Aux. Output 2	ATS Power N
Aux. Output 4	S1 Open Control
Aux. Output 6	Gen Start Output



SGQ-N/T Wiring Diagram

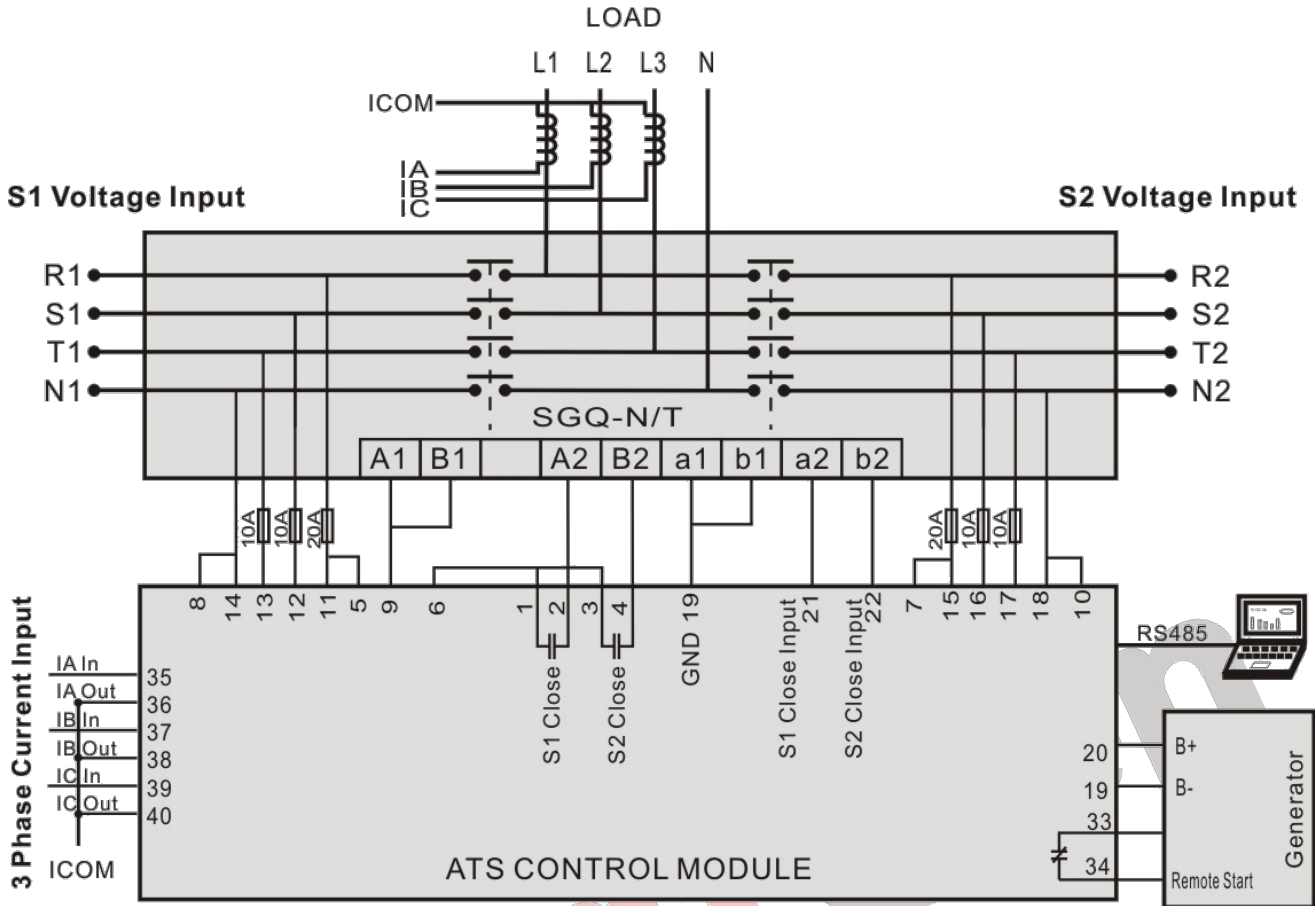

Parameters Setting	
Switch Type	PC Two-stage
Aux. Output 1	ATS Power L
Aux. Output 2	ATS Power N
Aux. Output 6	Gen Start Output

SGQ-M Wiring Diagram

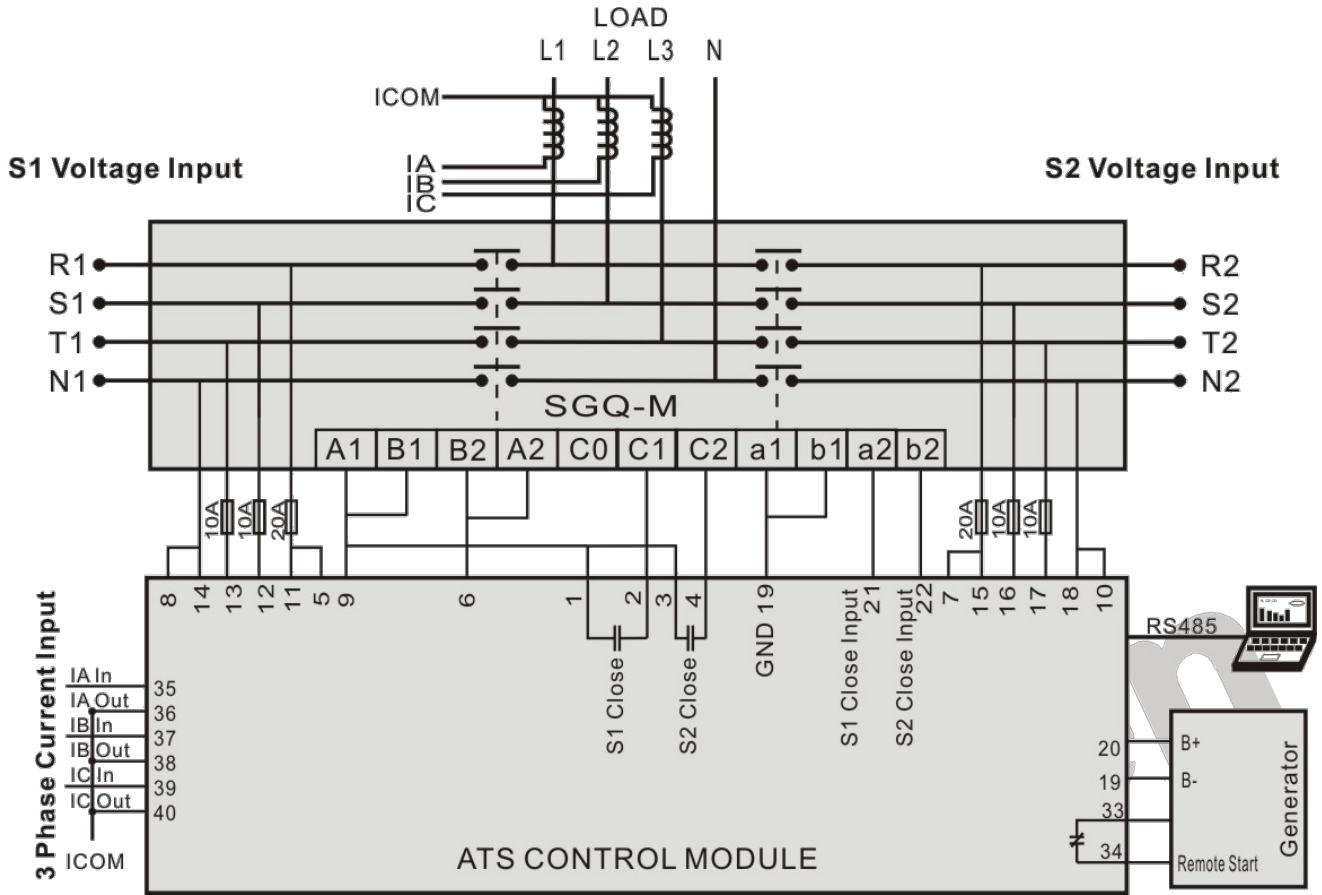

Parameters Setting	
Switch Type	PC Two-stage
Aux. Output 1	ATS Power L
Aux. Output 2	ATS Power N
Aux. Output 6	Gen Start Output

VITZRO/PHETENG Wiring Diagram

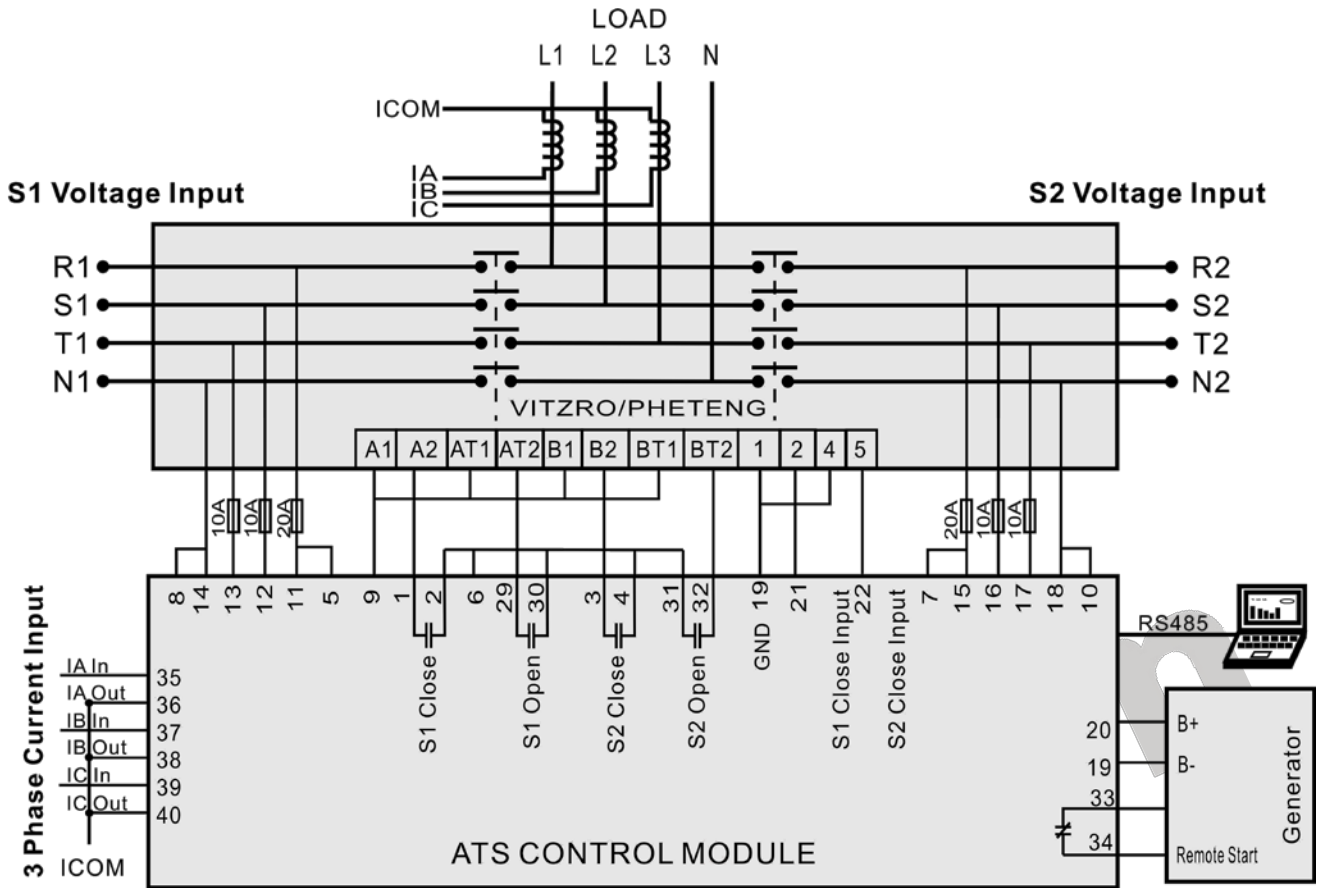

Parameters Setting	
Switch Type	CB/CC
Aux. Output 1	ATS Power L
Aux. Output 2	ATS Power N
Aux. Output 4	S1 Open Control
Aux. Output 5	S2 Open Control
Aux. Output 6	Gen Start Output



Contactor Wiring Diagram

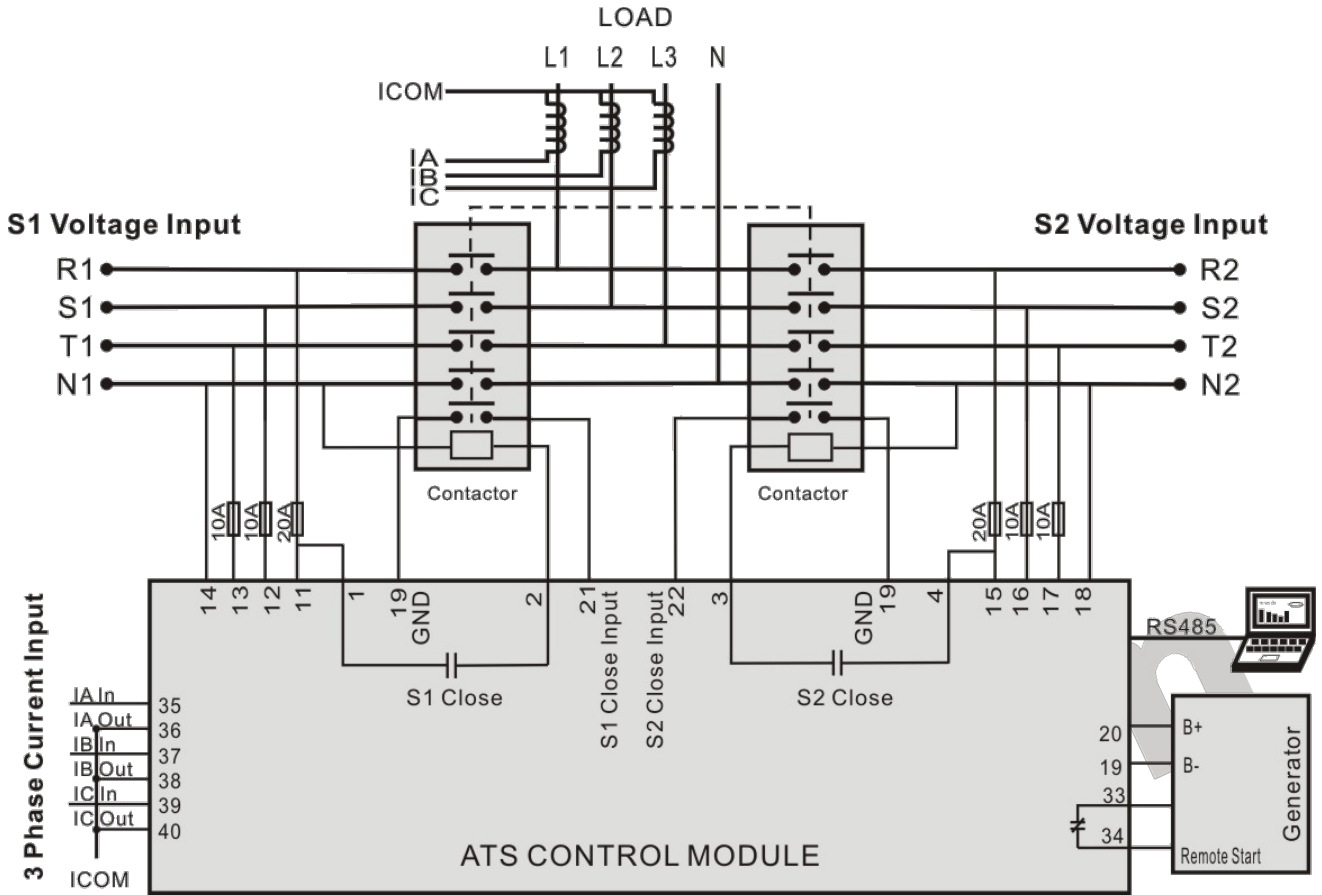

Parameters Setting	
Switch Type	CB/CC
Aux. Output 6	Gen Start Output
Close Continuous Out	Enable





ATYSM3S Wiring Diagram  
LOAD

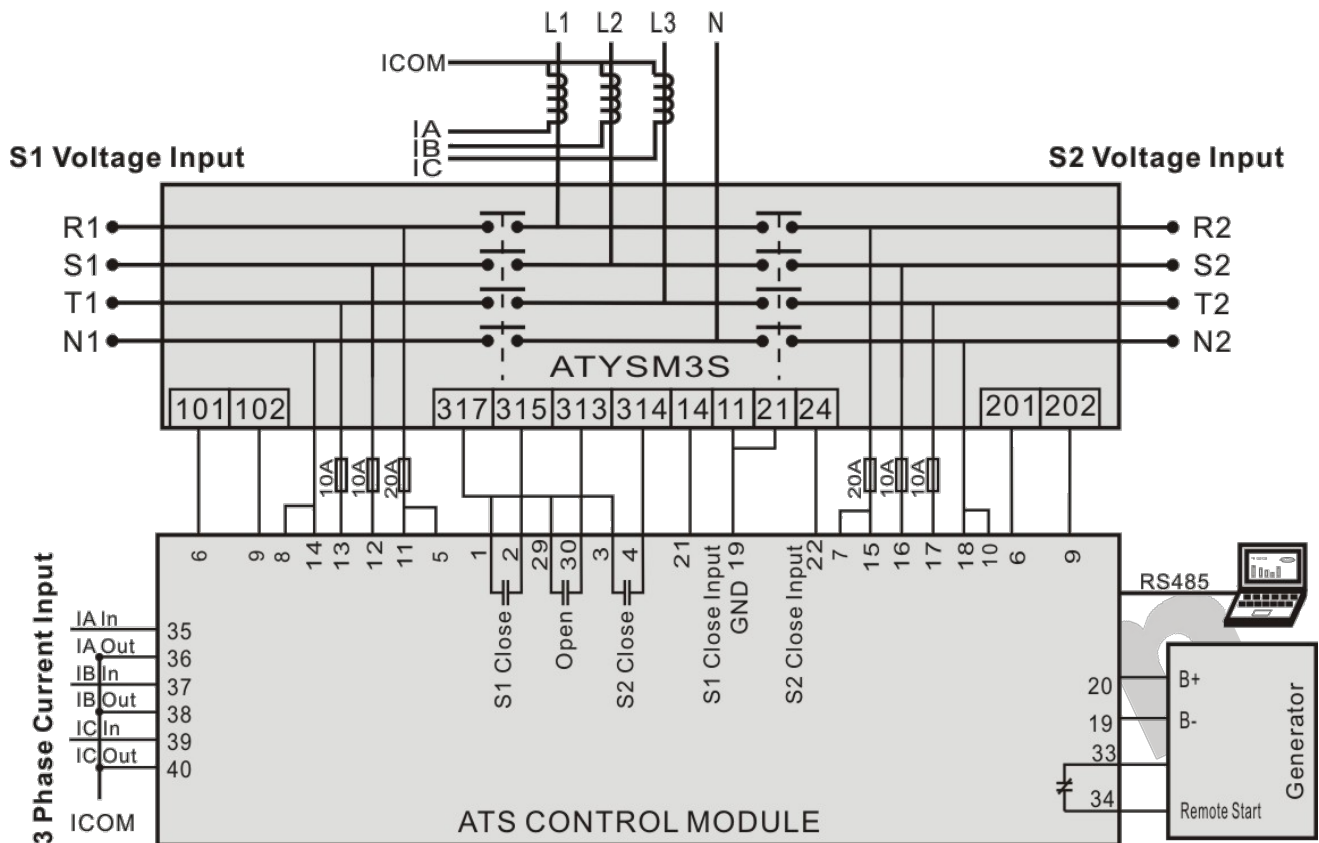

Parameters Setting	
Switch Type	PC Three-stage
Aux. Output 1	ATS Power L
Aux. Output 2	ATS Power N
Aux. Output 4	S1 Open Control
Aux. Output 6	Gen Start Output

Breaker Wiring Diagram

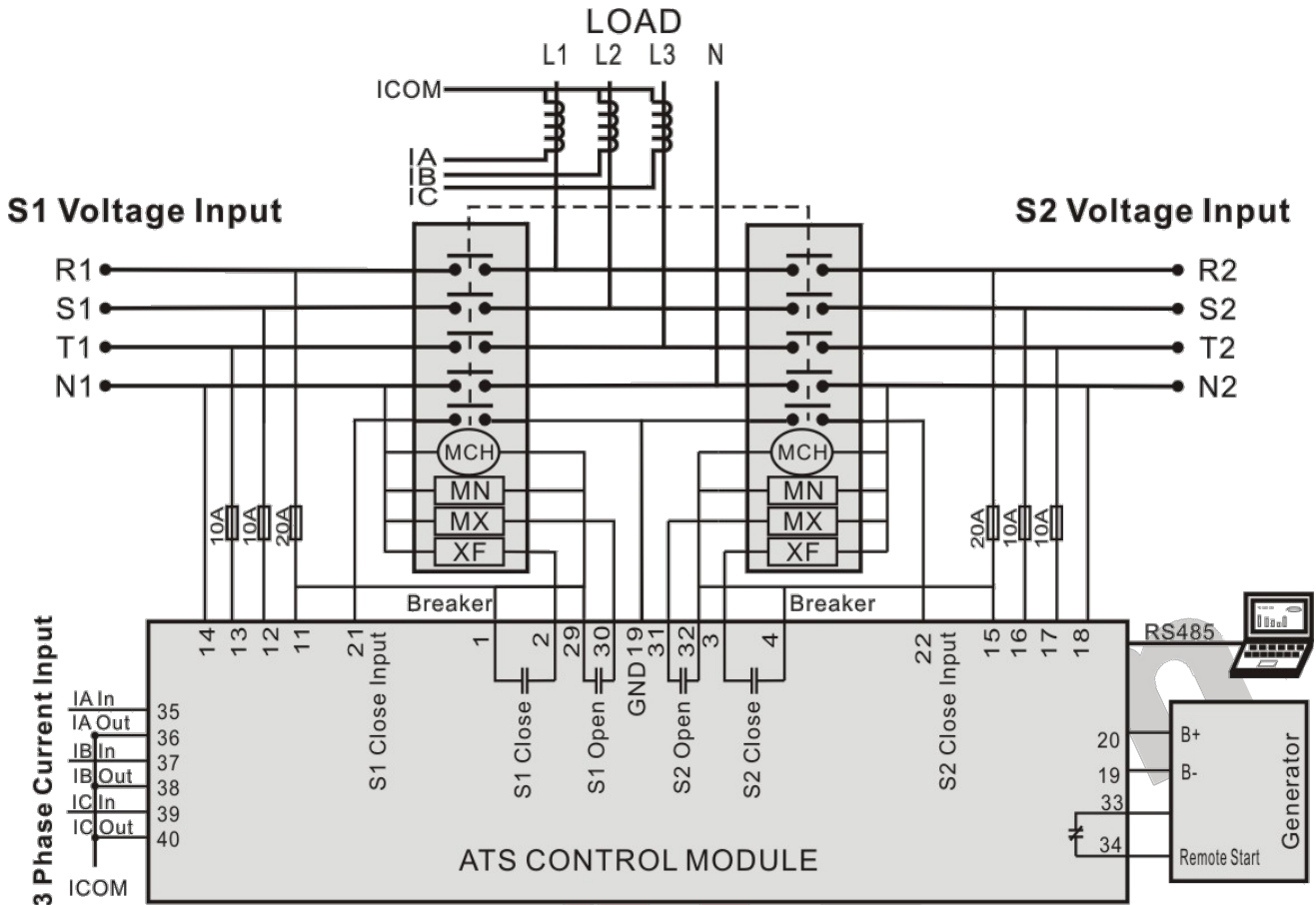

MCH: Stored Energy Motor; MN: Under Voltage Trip; MX: Open Relay; XF: Close Relay;

Parameters Setting	
Switch Type	CB/CC
Aux. Output 4	S1 Open Control
Aux. Output 5	S2 Open Control
Aux. Output 6	Gen Start Output

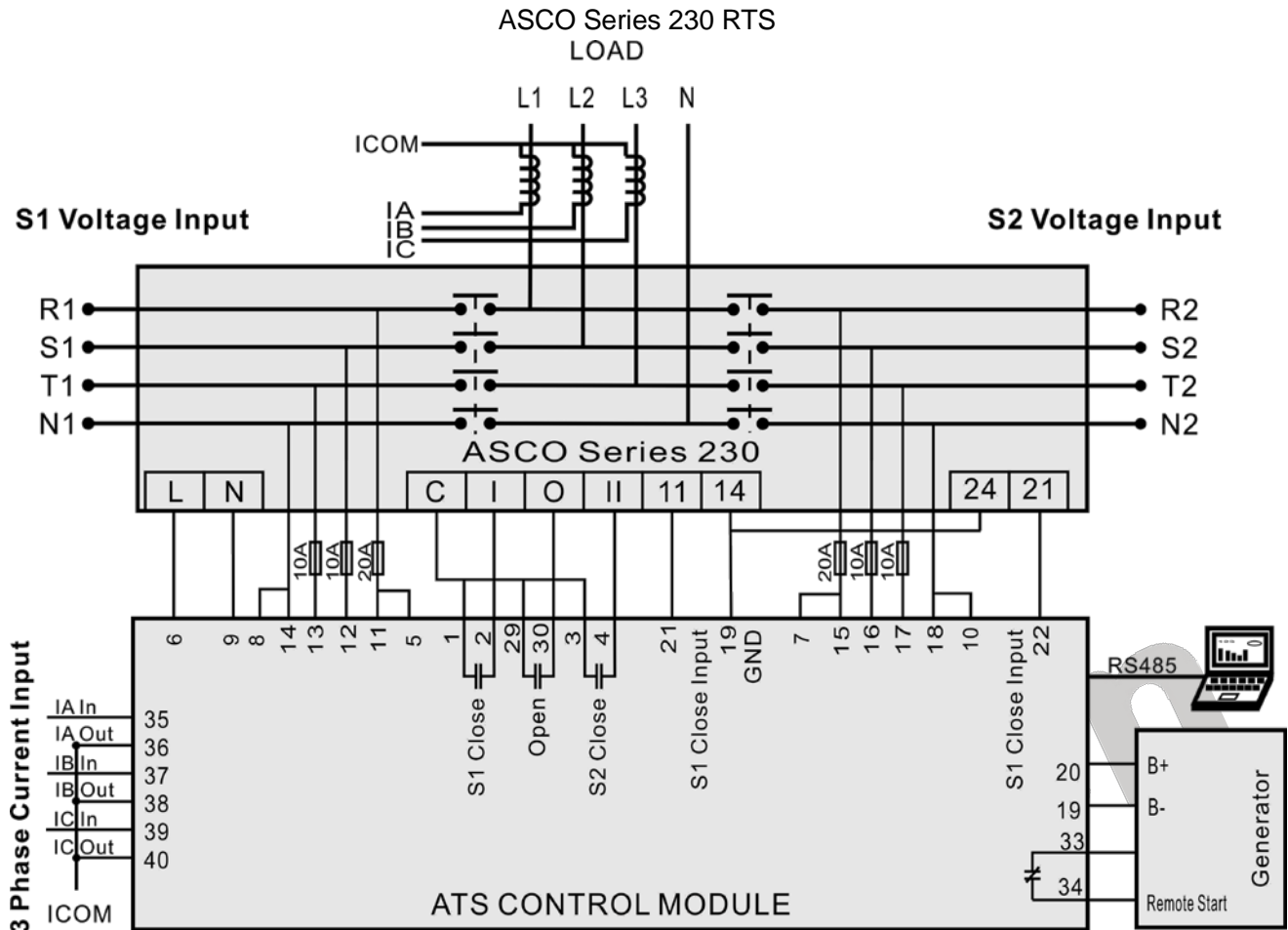

Parameters Setting	
Switch Type	PC Three-stage
Aux. Output 1	ATS Power L
Aux. Output 2	ATS Power N
Aux. Output 4	S1 Open Control
Aux. Output 6	Gen Start Output

**NOTE:** All above are application diagrams of HAT700 series ATS controllers. However, HAT700 and HAT700B have no sample current input, please skip over the current part of the diagram.

**Note:** Auxiliary Output 6 is default set as Genset Start Output (Normally Open) and there is only normally close contact in it. The controller also can control the genset start even if there is no power supply. If DC Power is selected, Genset Start Output port can be set as other items.

## 17 INSTALLATION

Controller is panel built-in design; it is fixed by clips when installed. The controller's overall dimensions and cutout dimensions for panel, please refers to as following,

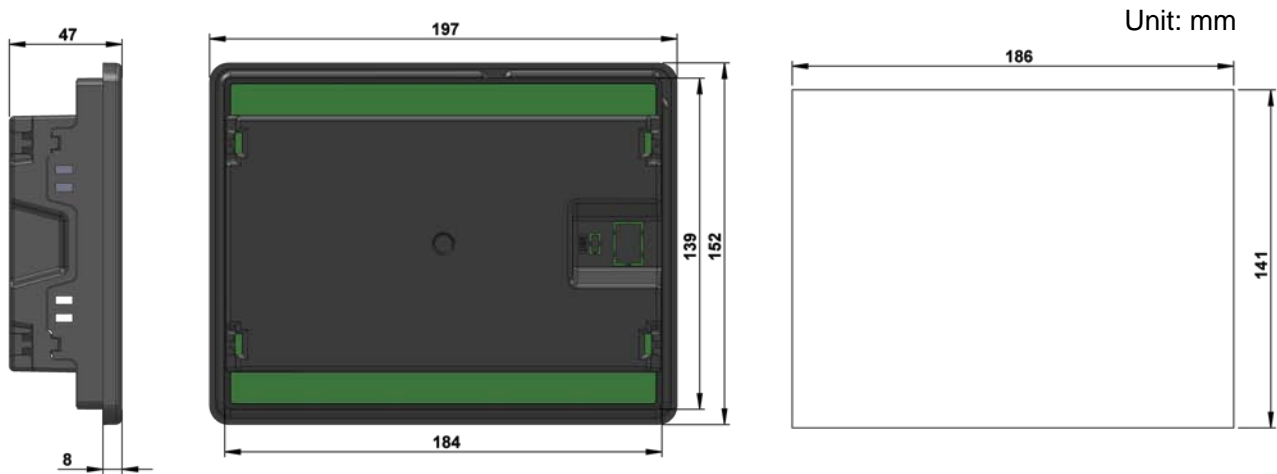

## 18 FAULT FINDING

Symptoms	Possible Solutions
Controller no response with power.	<ul style="list-style-type: none"> <li>Check DC voltage.</li> <li>Check DC fuse.</li> <li>Check AC Power supply.</li> </ul>
RS485 communication is abnormal	<ul style="list-style-type: none"> <li>Check RS485's connections of A and B is reverse connect or not.</li> <li>Check RS485 transfer model whether damage or not.</li> <li>Check the module address.</li> <li>If above methods can't solve the problem, parallel connection 120Ω resistor between RS485 A terminal and B terminal is recommended.</li> </ul>
Auxiliary Output Error	<ul style="list-style-type: none"> <li>Check auxiliary output connections, pay attention to normally open contact and normally close contact.</li> <li>Check the output settings in parameters settings.</li> </ul>
Auxiliary Input Abnormal	<ul style="list-style-type: none"> <li>Ensure that the auxiliary input is soundly connected to GND when it's active, while hung up when it is inactive.</li> <li>(▲Note: The input port will be possibly destroyed when connected with voltage)</li> <li>Check the input settings in parameters settings.</li> </ul>
Genset running while ATS not transfer	<ul style="list-style-type: none"> <li>Check ATS.</li> <li>Check the connection wirings between the controller and the ATS.</li> <li>Ensure that the switch type is same as the setting.</li> <li>Check ATS power and its connection.</li> </ul>
Genset Start Abnormal	<ul style="list-style-type: none"> <li>Check system type setting.</li> <li>Check the output settings in parameters settings.</li> <li>Check all Start/Stop settings.</li> </ul>